

SIEMENS



Totally Integrated Power

SIVACON S8

Technical Planning Information · 10/2015

Qualified Personnel

The product/system described in this documentation may be operated only by personnel qualified for the specific task in accordance with the relevant documentation, in particular its warning notices and safety instructions. Qualified personnel are those who, based on their training and experience, are capable of identifying risks and avoiding potential hazards when working with these products/systems.

Proper use of Siemens products

Note the following:



WARNING, death or severe personal injury may result if proper precautions are not taken.

Siemens products may only be used for the applications described in the catalog and in the relevant technical documentation. If products and components from other manufacturers are used, these must be recommended or approved by Siemens. Proper transport, storage, installation, assembly, commissioning, operation and maintenance are required to ensure that the products operate safely and without any problems. The permissible ambient conditions must be complied with. The information in the relevant documentation must be observed.

Disclaimer of Liability

We have reviewed the contents of this publication to ensure consistency with the hardware and software described. Since variance cannot be precluded entirely, we cannot guarantee full consistency. However, the information in this publication is reviewed regularly and any necessary corrections are included in subsequent editions.

SIVACON S8

Technical Planning Information

System-based power distribution	1
SIVACON S8 – System overview	2
Circuit-breaker design	3
Universal mounting design	4
In-line design, plug-in	5
Cubicles in fixed-mounted design	6
Reactive power compensation	7
Further planning notes	8
Conforming to standards and design-verified	9
Technical annex	10
Glossary and rated parameters	11

Content

1	System-based power distribution	4	8	Further planning notes	72
			8.1	Installation	72
2	SIVACON S8 – System overview	8	8.2	Weights and power loss	76
2.1	System configuration and cubicle design	10	8.3	Environmental conditions	77
2.2	Corner cubicle	15			
2.3	Main busbar, horizontal	16	9	Conforming to standards and design-verified	80
2.4	Connection points for earthing and short-circuit devices	17	9.1	The product standard IEC 61439-2	80
2.5	Overview of mounting designs	18	9.2	Arc resistance	81
			9.3	Seismic safety and seismic requirements	83
3	Circuit-breaker design	22	9.4	Declarations of conformity and certificates	85
3.1	Cubicles with one ACB (3WL)	24	10	Technical annex	92
3.2	Cubicles with up to three ACB (3WL)	29	10.1	Power supply systems according to their type of connection to earth	92
3.3	Cubicles with one MCCB (3VL)	30	10.2	Loads and dimensioning	95
3.4	Cubicles for direct supply and direct feeder	31	10.3	Degrees of protection according to IEC 60529	97
			10.4	Forms of internal separation based on IEC 61439-2	98
4	Universal mounting design	34	10.5	Operating currents of three-phase asynchronous motors	99
4.1	Fixed-mounted design with compartment door	37	10.6	Three-phase distribution transformers	100
4.2	In-line switch-disconnectors with fuses (3NJ62 / SASIL plus)	38			
4.3	Withdrawable design	38	11	Glossary and rated parameters	102
			11.1	Terms and definitions	102
5	In-line design, plug-in	50	11.2	Rated parameters	104
5.1	In-line switch-disconnectors 3NJ62 with fuses	51	11.3	Index of tables	106
5.2	In-line switch-disconnectors SASIL plus with fuses	53	11.4	Index of figures	108
6	Cubicles in fixed-mounted design	56			
6.1	In-line design, fixed-mounted	56			
6.2	Fixed-mounted design with front cover	59			
6.3	Cubicle for customized solutions	63			
7	Reactive power compensation	66			
7.1	Configuration and calculation	68			
7.2	Separately installed compensation cubicles	70			

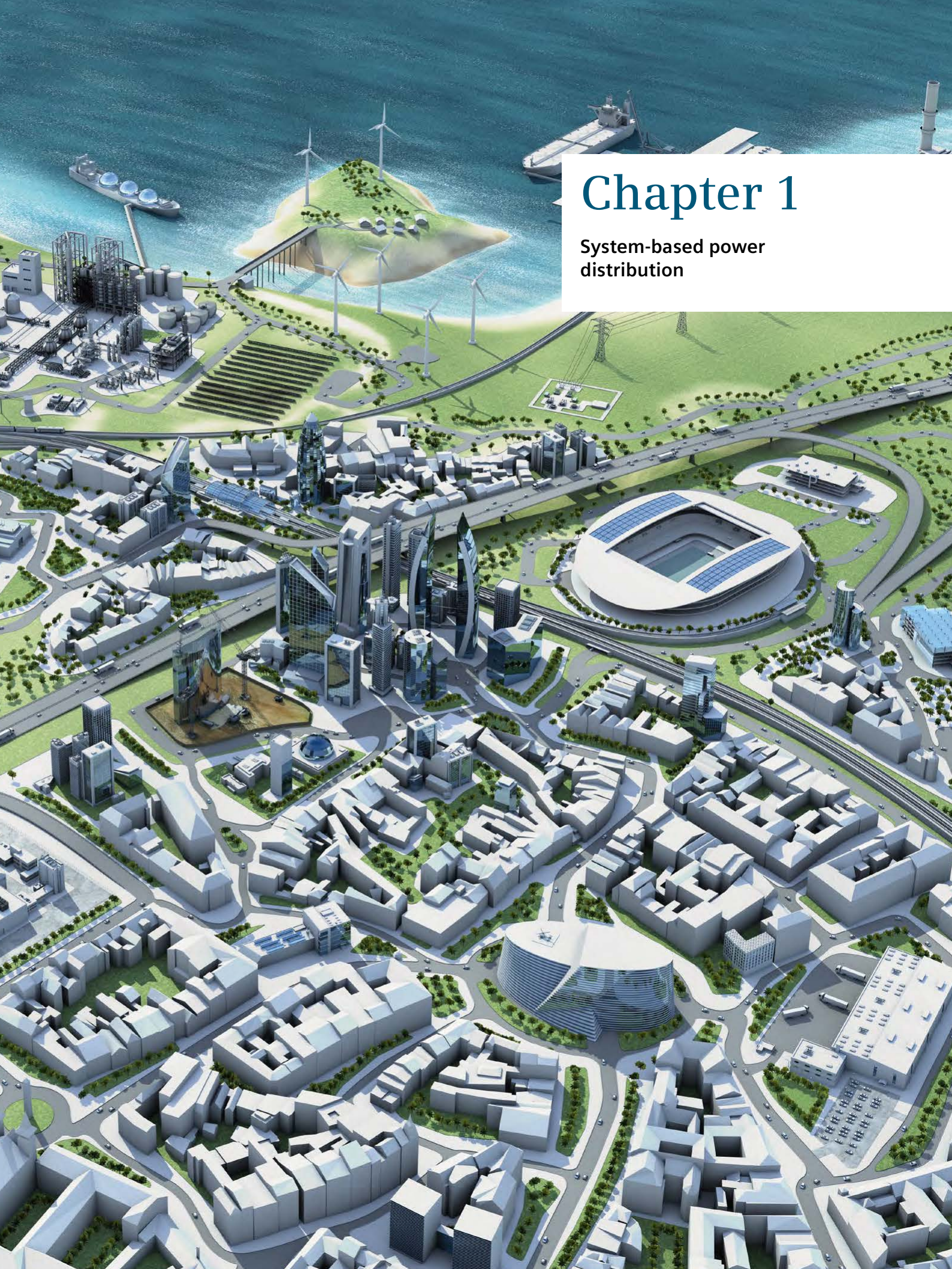

Chapter 1

System-based power
distribution

1 System-based power distribution

When a power distribution concept is to be developed which includes dimensioning of systems and devices, its requirements and feasibility have to be matched by the end user and the manufacturer. We have prepared this planning manual for the SIVACON S8 low-voltage switchboard to support you with this task. Three principles must be observed for optimal power distribution:

- Safety - integrated
- Economic efficiency - right from the start
- Flexibility – through modularity

Comparable to a main artery, electric power supply constitutes the basis for reliable and efficient functioning of all electrically operated facilities. Electrical power distribution requires integrated solutions. Totally Integrated Power (TIP) is a synonym for integrated electrical power distribution (Fig. 1/1) in industrial applications, infrastructure projects and buildings.

SIMARIS planning tools

The SIMARIS planning tools by Siemens provide efficient support for dimensioning electric power distribution systems and determine the devices and distribution boards required for them.

- SIMARIS design for network calculation and dimensioning
- SIMARIS project for determining the space requirements of distribution boards and the budget, and for generating specifications (bills of quantities)
- SIMARIS curves for visualising characteristic tripping curves, cut-off current and let-through energy curves.

Further information about TIP:
www.siemens.com/tip

Further information about SIMARIS:
www.siemens.com/simaris

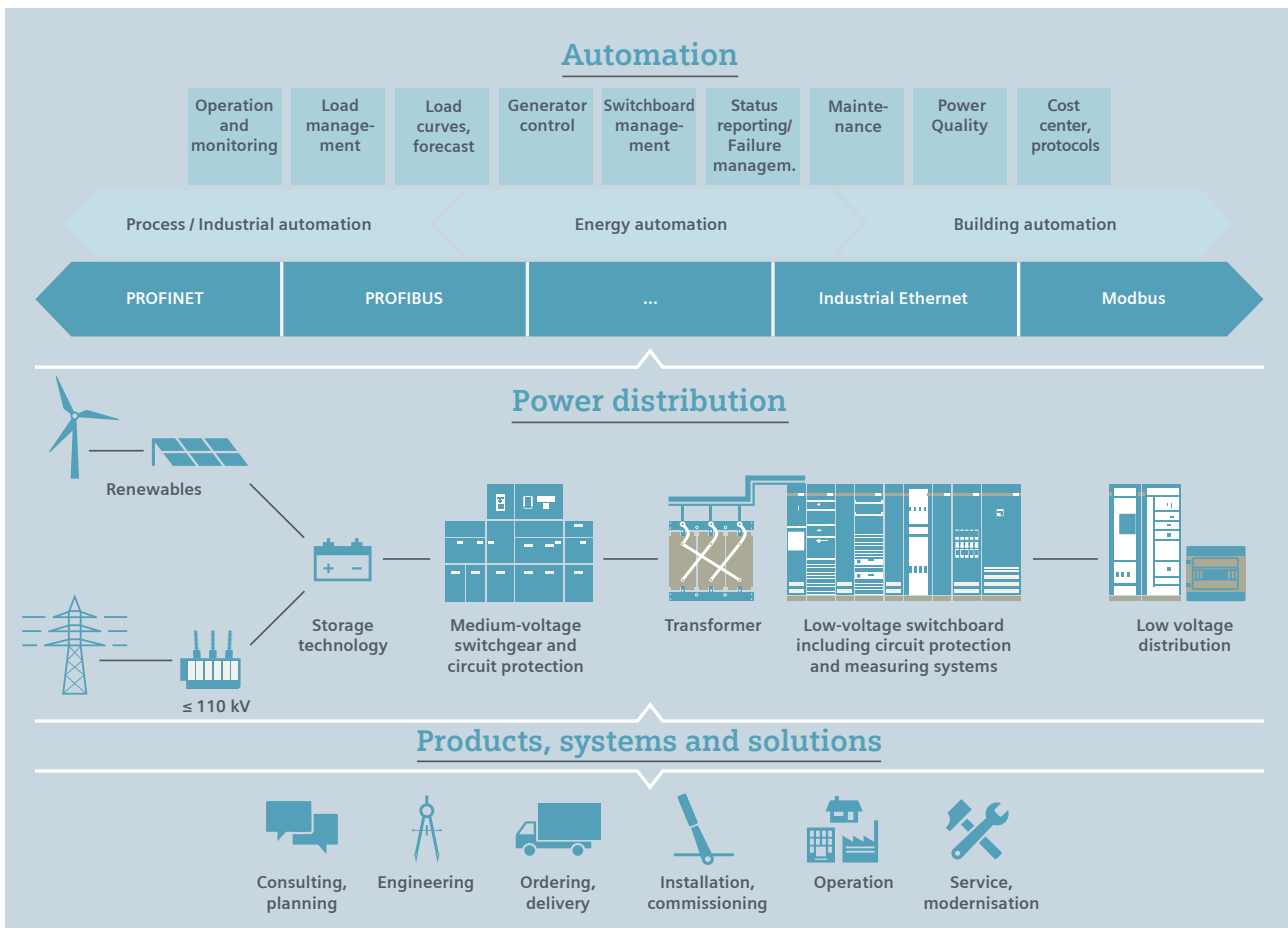

Fig. 1/1: Totally Integrated Power (TIP) as holistic approach to electric power distribution

SIMARIS configuration tools

Configuring and dimensioning a low-voltage switchboard is very complex. SIVACON S8 switchboards are configured by experts, effectively supported by the SIMARIS configuration tools during the stages of switchboard manufacture, operation and maintenance:

- SIMARIS configuration for tender drawing up, order processing and manufacturing the SIVACON S8 switchboard
- SIMARIS control to efficiently create visualisation systems for operating and monitoring the SIVACON S8 switchboard

Cost-efficient complete system

The SIVACON S8 low-voltage switchboard sets new standards worldwide as power distribution board (PDB) or motor control center (MCC) for industrial applications or in infrastructure projects (Fig. 1/2). The switchboard system up to 7,000 A for easy and integrated power distribution ensures maximum personal safety and plant protection and provides many possibilities for use due to its optimal design. Its modular construction allows the switchboard to be optimally matched to any requirement when the whole plant is designed. Maximum safety and modern design now complement each other in an efficient switchboard.

Tested safety

SIVACON S8 is a synonym for safety at the highest level. The low-voltage switchboard is a design-verified low-voltage switchgear and controlgear assembly in accordance with IEC 61439-2. Design verification is performed by testing. Its physical properties were verified in the test area both for operating and fault situations. Maximum personal safety is also ensured by a test verification under arcing fault conditions in accordance with IEC/TR 61641.

Flexible solutions

The SIVACON S8 switchboard is the intelligent solution which adapts itself to your requirements. The combination of different mounting designs within one cubicle is unique. The flexible, modular design allows functional units to be easily replaced or added. All SIVACON S8 modules are subject to a continuous innovation process and the complete system always reflects the highest level of technical progress.

Further information about SIVACON S8:
www.siemens.com/sivacon-s8

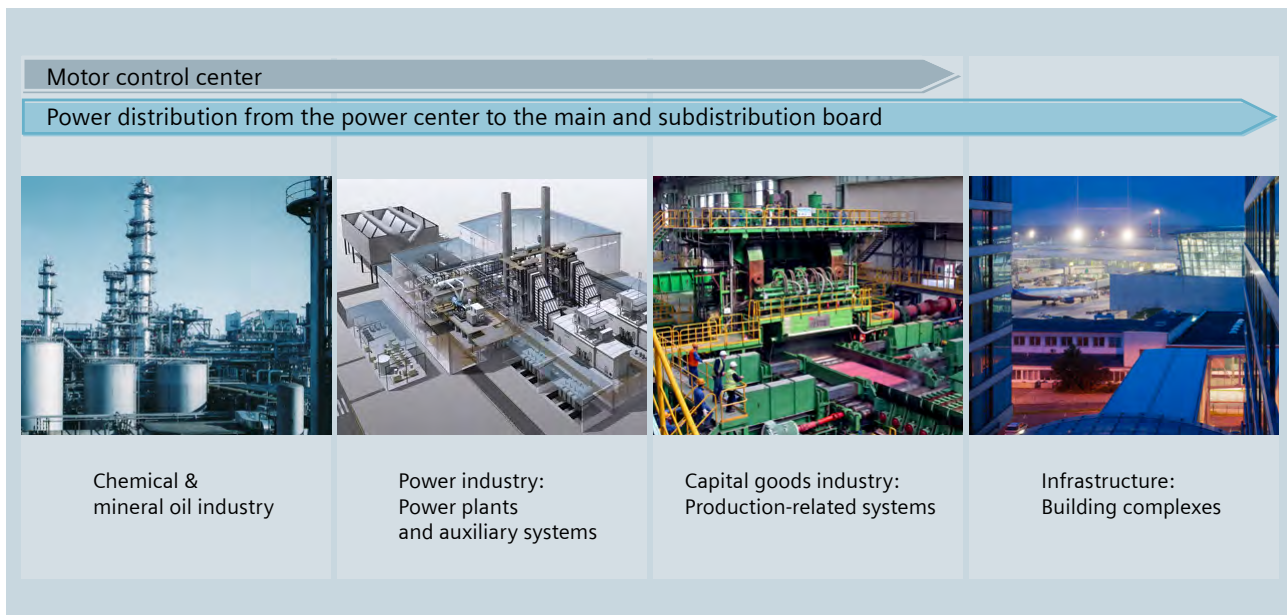

Fig. 1/2: SIVACON S8 for all areas of application

Use

SIVACON S8 can be used at all application levels in the low-voltage network (Fig. 1/3):

- Power center or secondary unit substation
- Main switchboard or main distribution board
- Subdistribution board, motor control center, distribution board for installation devices or industrial use

Advantages of modular design

Every SIVACON S8 switchboard is manufactured of demand-oriented, standardised, and series-produced modules. All modules are tested and of a high quality. Virtually every requirement can be satisfied due to the manifold module combination possibilities. Adaptations to new performance requirements can easily and rapidly be implemented by replacing or adding modules.

The advantages offered by this modular concept are clear:

- Verification of safety and quality for every switchboard
- Fulfilment of each and every requirement profile combined with the high quality of series production
- Easy placement of repeat orders and short delivery time

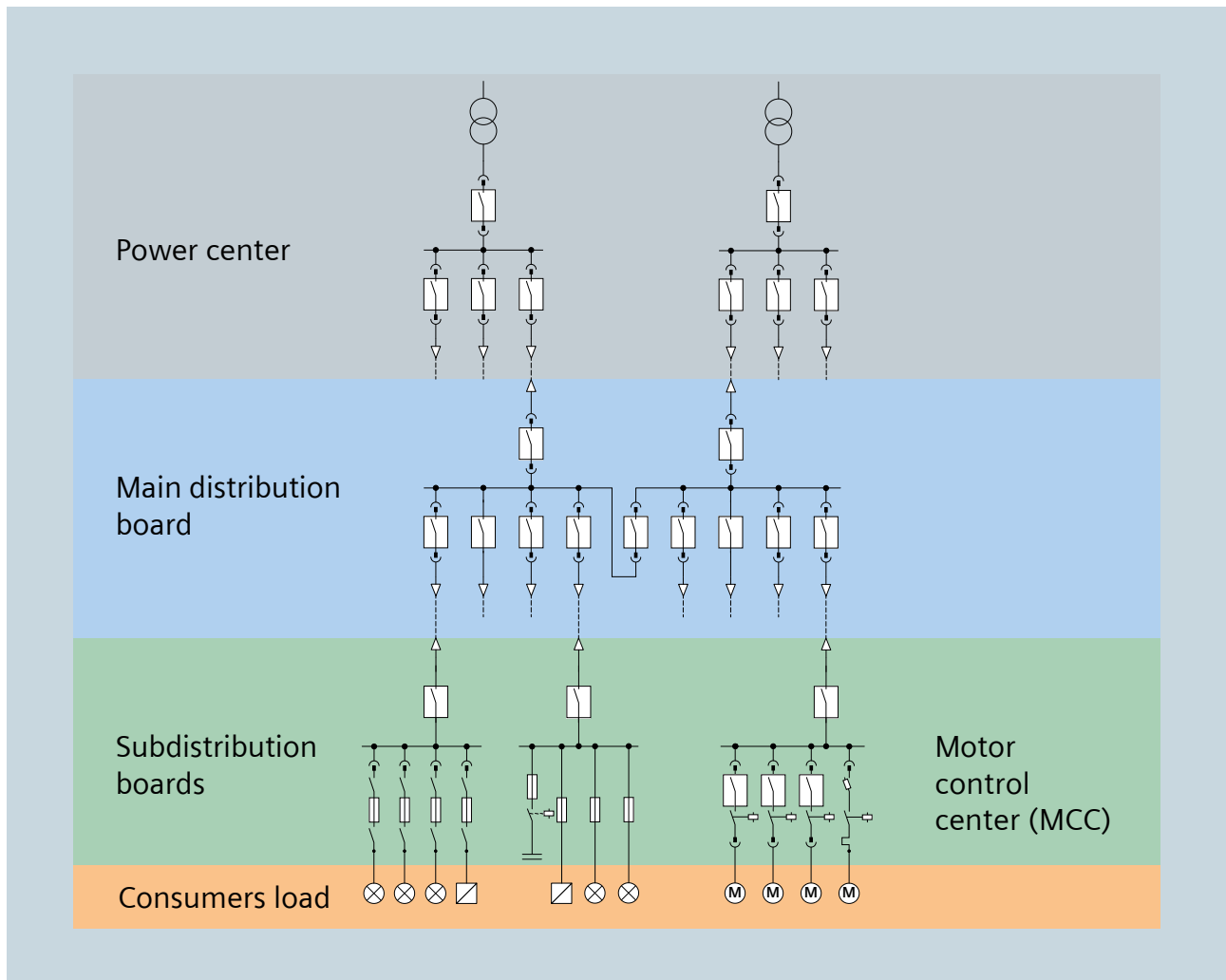

Fig. 1/3: Use of SIVACON S8 in power distribution

Chapter 2

SIVACON S8 – System overview

2.1	System configuration and cubicle design	10
2.2	Corner cubicle	15
2.3	Main busbar, horizontal	16
2.4	Connection points for earthing and short-circuit devices	17
2.5	Overview of mounting designs	18



2 SIVACON S8 – System overview

The interaction of the components described below results in an optimal low-voltage switchboard with advantages as regards:

- Safety - integrated
- Economic efficiency - right from the start
- Flexibility – through modularity

Tab. 2/1: Technical data, standards and approvals for the SIVACON S8 switchboard

Standards and approvals		
Standards and regulations	Power switchgear and controlgear assembly (design verification)	IEC 61439-2 DIN EN 61439-2-2 VDE 0660-600-2
	Test of internal fault behaviour (internal arc)	IEC/TR 61641 DIN EN 60439-1 Supplement 2 VDE 0660-500 Supplement 2
	Induced vibrations	IEC 60068-3-3 IEC 60068-2-6 IEC 60068-2-57 IEC 60980 KTA 2201.4 Uniform Building Code (UBC), Edition 1997 Vol. 2, Ch. 19, Div. IV
	Protection against electric shock	EN 50274 (VDE 0660-514)
Approvals	Europe Russia, Belarus, Kazakhstan China	CE marking and EC Declaration of Conformity EAC CCC
	Det Norske Veritas Lloyds Register of Shipping	DNV GL Type Approval Certificate LR Type Approval Certificate
	Shell conformity	"DEP Shell"
Technical data		
Installation conditions	Indoor installation, ambient temperature in the 24-h mean	+ 35 °C (-5 °C to + 40 °C)
Rated operating voltage (U_e)	Main circuit	Up to 690 V (rated frequency f_n 50 Hz)
Dimensioning of creepage distances and clearances	Rated impulse withstand voltage U_{imp}	8 kV
	Rated insulation voltage (U_i)	1,000 V
	Degree of pollution	3
Main busbars, horizontal	Rated current	Up to 7,010 A
	Rated peak withstand current (I_{pk})	Up to 330 kA
	Rated short-time withstand current (I_{cw})	Up to 150 kA, 1s
Rated device currents	Circuit-breakers	Up to 6,300 A
	Cable feeders	Up to 630 A
	Motor feeders	Up to 630 A
Internal separation	IEC 61439-2	Form 1 to form 4
	BS EN 61439-2	Up to form 4 type 7
IP degree of protection	in accordance with IEC 60529	Ventilated up to IP43 Non-ventilated IP54
Mechanical strength	IEC 62262	Up to IK10
Dimensions	Height (without base)	2,000, 2,200 mm
	Height of base (optional)	100, 200 mm
	Cubicle width	200, 350, 400, 600, 800, 850, 1,000, 1,200, 1,400 mm
	Depth (single-front)	500, 600, 800, 1,000, 1,200 mm

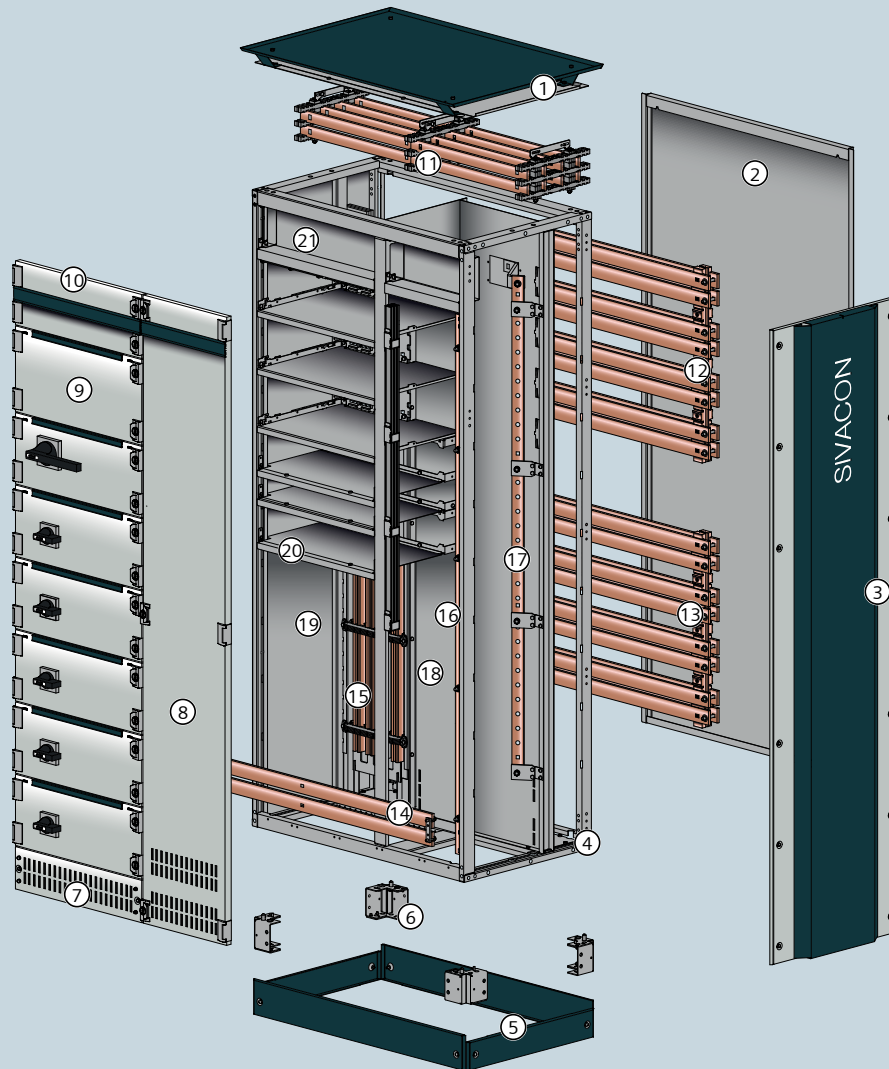

Enclosure

- ① Roof plate
- ② Rear panel
- ③ Design side panel
- ④ Frame
- ⑤ Base cover
- ⑥ Base
- ⑦ Ventilated base compartment cover
- ⑧ Ventilated cubicle door
- ⑨ Compartment door
- ⑩ Head room door

Busbars

- ⑪ Main busbar (L1... L3, N) – top
- ⑫ Main busbar (L1... L3, N) – rear top
- ⑬ Main busbar (L1... L3, N) – rear bottom
- ⑭ Main busbar (PE) – bottom
- ⑮ Vertical distribution busbar system (L1... L3, N) device compartment
- ⑯ Vertical distribution busbar (PE) cable connection compartment
- ⑰ Vertical distribution busbar (N) cable connection compartment

Internal separation

- ⑱ Device compartment/busbar compartment
- ⑲ Cubicle to cubicle
- ⑳ Compartment to compartment
- ㉑ Cross-wiring compartment

Fig. 2/1: Cubicle design of SIVACON S8

2.1 System configuration and cubicle design

When the system configuration is planned, the following characteristics must be specified:

- Busbar position (top, rear top, rear bottom, or both rear top and rear bottom)
- Single-front or double-front design
- Cable/busbar entry (from the top or bottom)
- Connection in cubicle (front or rear)

Tab. 2/2: Schematic overview of switchboard configurations for SIVACON S8

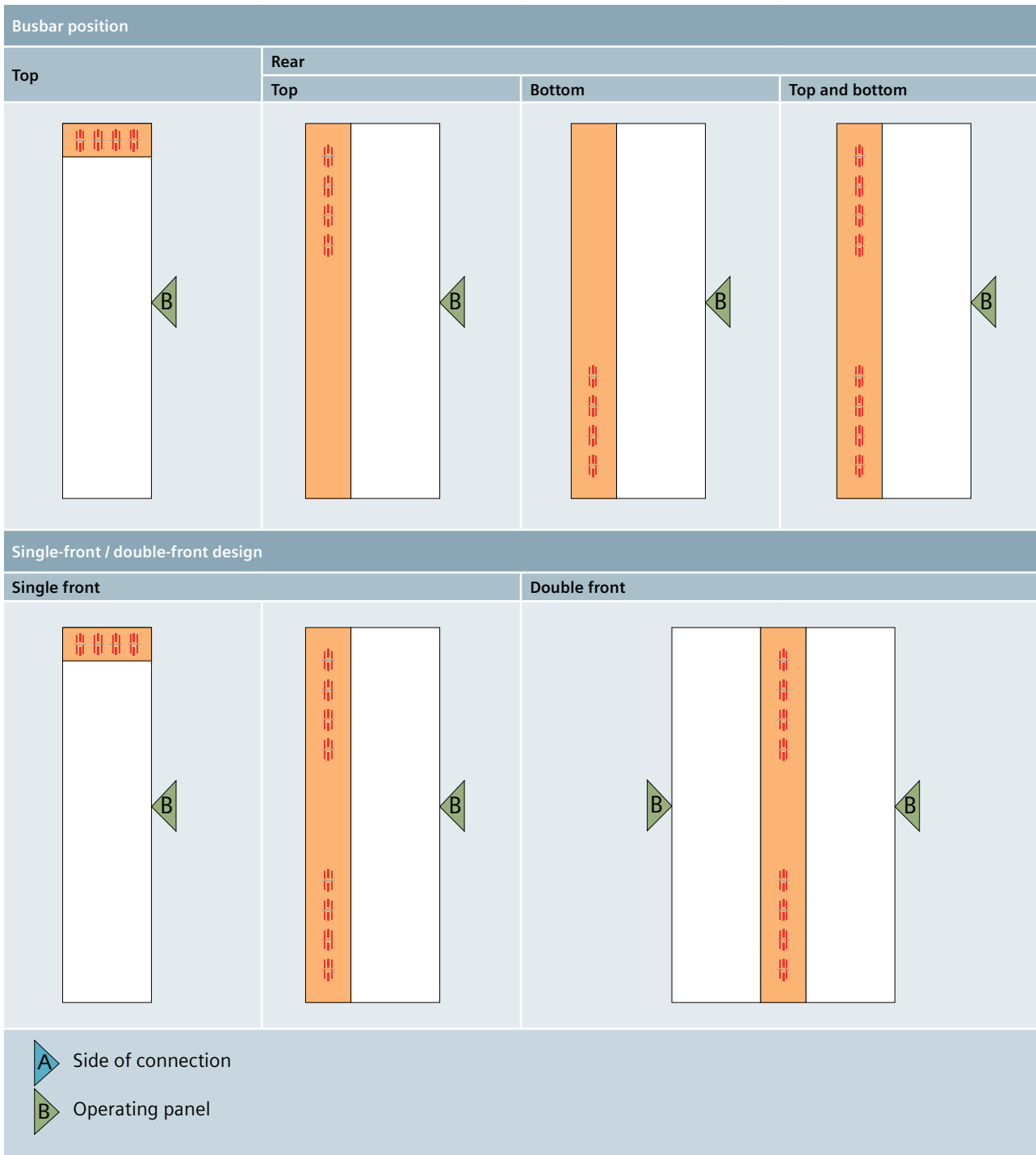

These characteristics depend on the type of installation among other things:

- Stand-alone
- At the wall (only for single-front design)
- Back to back (only for single-front design)

These determinations allow to specify cubicle design in more detail (Fig. 2/1, Tab. 2/2 and Tab. 2/3). Further information about the switchboard installation can be found in Chapter 8 "Further planning notes".

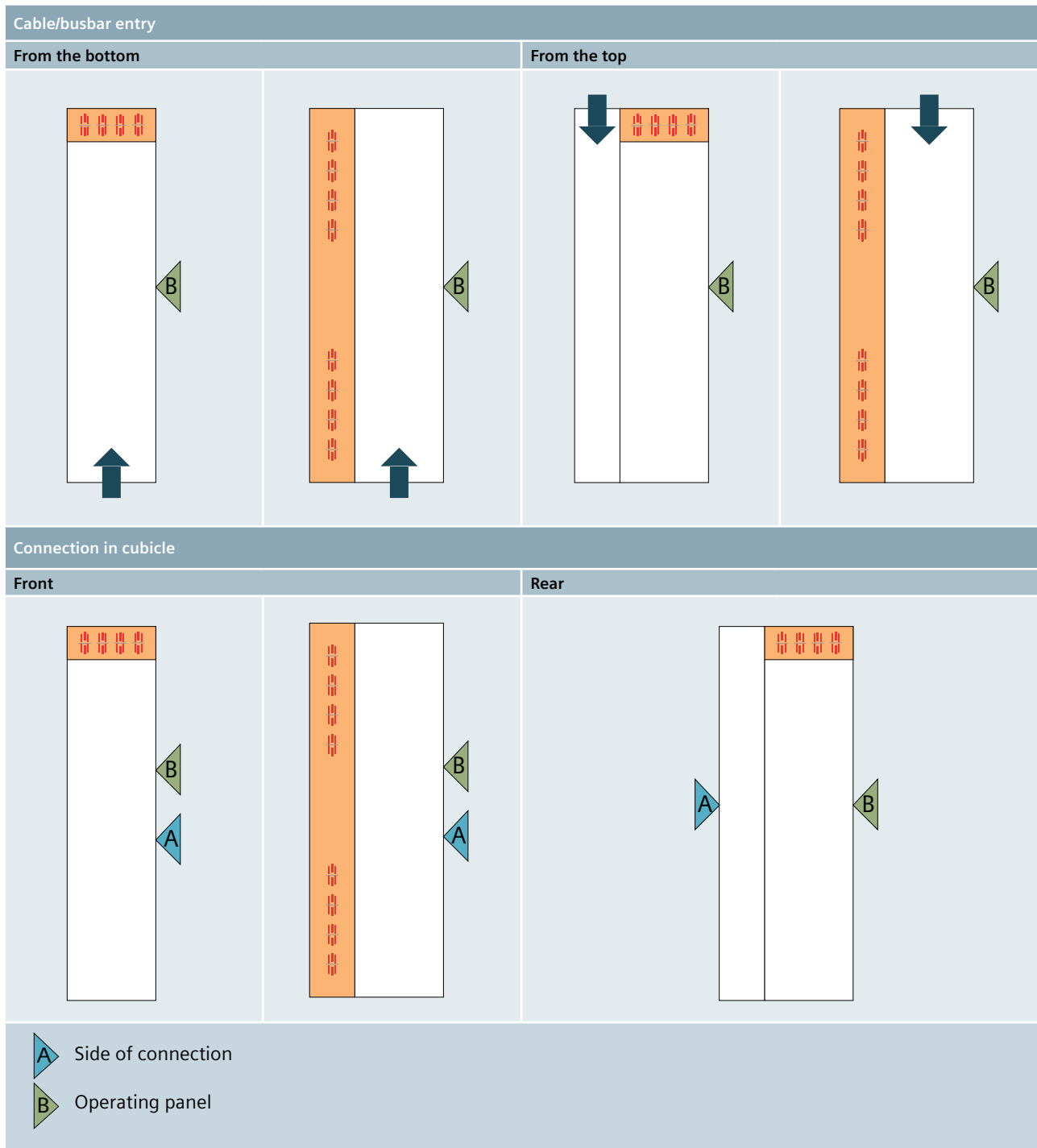

1

2

3

4

5

6

7

8

9

10

11

Tab. 2/3: Cubicle types and busbar arrangement

Top busbar position		
Busbar system		Cubicle design
Busbar position Rated current Cable/busbar entry Connection in cubicle	Top Up to 3,270 A Bottom Front	
Busbar position Rated current Cable/busbar entry Connection in cubicle	Top Up to 3,270 A Top Front or rear	
Busbar position Rated current Cable/busbar entry Connection in cubicle	Top Up to 6,300 A Bottom Front	
Busbar position Rated current Cable/busbar entry Connection in cubicle	Top Up to 6,300 A Top Front or rear	

Device/functional compartment

Busbar compartment

Cable / busbar connection compartment

Cross-wiring compartment

Operating panels

Rear busbar position		
Busbar system		Cubicle design
Busbar position Rated current Cable/busbar entry Connection in cubicle	Rear Top or bottom Top and bottom Up to 4,000 A Bottom or top Front	
Busbar position Rated current Cable/busbar entry Connection in cubicle	Rear Top or bottom Up to 7,010 A Bottom or top Front	
Busbar position Rated current Cable/busbar entry Connection in cubicle	Rear Top or bottom Top and bottom Up to 6,300 A Bottom or top Front	
Busbar position Rated current Cable/busbar entry Connection in cubicle	Rear Top or bottom Up to 7,010 A Bottom, top Front	
<div style="display: flex; justify-content: space-around; align-items: center;"> <div style="display: flex; align-items: center;"> <div style="width: 20px; height: 20px; background-color: #004a99; margin-right: 5px;"></div> Device/functional compartment </div> <div style="display: flex; align-items: center;"> <div style="width: 20px; height: 20px; background-color: #ff9933; margin-right: 5px;"></div> Busbar compartment </div> <div style="display: flex; align-items: center;"> <div style="width: 20px; height: 20px; background-color: #cccccc; margin-right: 5px;"></div> Cable / busbar connection compartment </div> <div style="display: flex; align-items: center;"> <div style="width: 20px; height: 20px; background-color: #ffffff; border: 1px solid black; margin-right: 5px;"></div> Cross-wiring compartment </div> <div style="display: flex; align-items: center;"> <div style="width: 10px; height: 10px; border-left: 1px solid black; border-right: 1px solid black; margin-right: 5px;"></div> Operating panels </div> </div>		

1
2
3
4
5
6
7
8
9
10
11

Tab. 2/4: Cubicle dimensions

Cubicle height					
Frame	2,000, 2,200 mm				
Base	Without, 100, 200 mm				
Cubicle width					
Dependent of:	- Cubicle type - Rated device current - Connecting position and/or cable/busbar entry				
Cubicle depth					
Type	Main busbar		Cubicle depth		
	Location	Rated current	Front connection		Rear connection
			Entry from the bottom	Entry from the top	
Single front	Top	3,270 A	500, 800 mm	800 mm	800 mm
		6,300 A ¹⁾	800, 1,000 mm	1,200 mm	1,200 mm
	Rear	4,000 A	600 mm	600 mm	-
		7,010 A	800 mm	800 mm	-
Double front	Rear	4,000 A	1,000 mm	1,000 mm	-
		7,010 A ¹⁾	1,200 mm	1,200 mm	-

¹⁾ Frame height 2,200 mm

The cubicle dimensions listed in Tab. 2/4 do not factor in the enclosure parts and no outer built-on parts.

For the dimensions of the cubicles' enclosure parts, please refer to Fig. 2/2. For degrees of protection IPX1 and IPX3, additional ventilation roof panels are mounted on the cubicle.

The dimensions of the enclosure parts are within the required minimum clearances for erecting the switchboard. Doors can be fitted so that they close in escape direction.

The door stop can easily be changed later. The door hinges allow for a door opening angle of up to 180° in case of single installation of a cubicle and at least 125° when cubicles are lined up. For more details, please refer to Chapter 8 "Further planning notes". The condition of surfaces of structural and enclosure parts is described in Tab. 2/5.

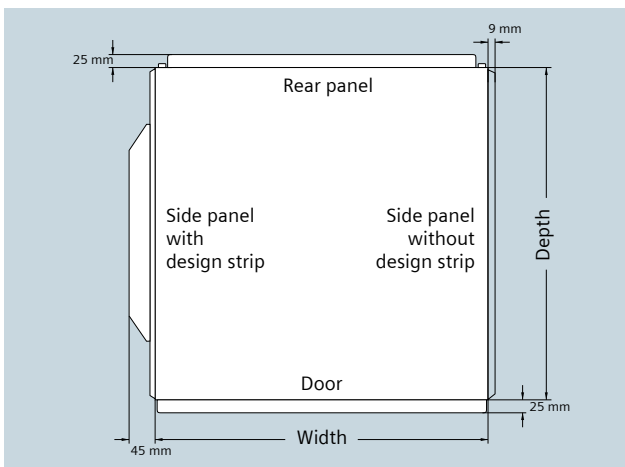

Fig. 2/2: Dimensions of enclosure parts

Tab. 2/5: Surface treatment

Surface treatment	
Frame components	Sendzimir-galvanised
Enclosure	Sendzimir-galvanised / powder-coated
Doors	Powder-coated
Copper bars	Bare copper, optionally silver-plated, optionally tin-plated
Colour	
Powder-coated components (layer thickness 100 ± 25 µm)	RAL7035, light grey (in accordance with DIN 43656) or upon request
Design components	Blue Green Basic

2.2 Corner cubicle

The corner cubicle connects two segments, positioned at right angles to each other, of a switchboard in single-board design (Fig. 2/3). The corner cubicle contains as functional rooms only the busbar compartment and the cross-wiring compartment. These compartments cannot be accessed via doors. The frame width resp. frame depth of the cubicles are listed in Tab. 2/6.

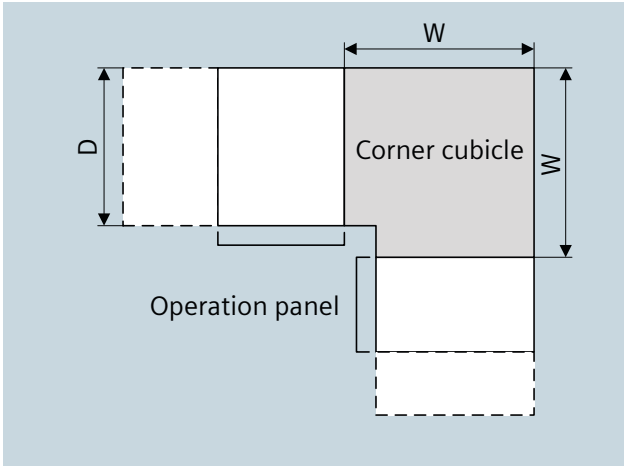

Fig. 2/3: Integration of the corner cubicle

Tab. 2/6: Dimensions of the corner cubicles

Cubicle depth D	Frame width / depth W of the corner cubicle
500 mm	600 mm
600 mm	700 mm
800 mm	900 mm
1,200 mm	900 mm

1

2

3

4

5

6

7

8

9

10

11

2.3 Main busbar, horizontal

Tab. 2/7 lists the rating data for the two possibilities how to position the main busbar – top or rear – (Fig. 2/4). Chapter 10 describes how ambient temperatures must be observed in respect of the current carrying capacity.



Fig. 2/4: Variable busbar position for SIVACON S8

Tab. 2/7: Rating of the main busbar

Top busbar position		
Rated current I_n at 35 °C ambient temperature		Rated short-time withstand current I_{cw} (1 s)
Ventilated	Non-ventilated	
1,190 A	965 A	35 kA
1,630 A	1,310 A	50 kA
1,920 A	1,480 A	65 kA
2,470 A	1,870 A	85 kA
3,010 A	2,250 A	100 kA
3,270 A	2,450 A	100 kA
3,700 A ¹⁾	3,000 A ¹⁾	100 kA
4,660 A ¹⁾	3,680 A ¹⁾	100 kA
5,620 A ¹⁾	4,360 A ¹⁾	150 kA
6,300 A ¹⁾	4,980 A ¹⁾	150 kA

¹⁾ If circuit-breakers with a very high power loss are used, the following correction factors must be applied:
 3WL1350: 0.95
 3WL1363: 0.88

Rear busbar position ¹⁾		
Rated current I_n at 35 °C ambient temperature		Rated short-time withstand current I_{cw} (1 s)
Ventilated	Non-ventilated	
1,280 A	1,160 A	50 kA
1,630 A	1,400 A	65 kA
2,200 A	1,800 A	65 kA
2,520 A	2,010 A	85 kA
2,830 A	2,210 A	100 kA
3,170 A	2,490 A	100 kA
4,000 A	3,160 A	100 kA
4,910 A ²⁾	3,730 A ²⁾	100 kA
5,340 A ²⁾	4,080 A ²⁾	100 kA
5,780 A ²⁾	4,440 A ²⁾	100 kA
7,010 A ²⁾	5,440 A ²⁾	150 kA

¹⁾ When operating two systems per cubicle at the same time (busbar position rear top and rear bottom), a reduction factor has to be considered:
 for ventilated boards: 0,94
 for unventilated boards: 0,98

²⁾ Busbar position rear top or rear bottom

2.4 Connection points for earthing and short-circuit devices

Short-circuiting and earthing devices (SED)

For short-circuiting and earthing, short-circuiting and earthing devices (SED) are available. For mounting the SED, appropriate fastening points are fitted at the points to be earthed. To accommodate the SED for the main busbar, a cubicle for customized solutions is inserted (see Chapter 6.3 "Cubicle for customized solutions"). The cubicle widths are given in Tab. 2/8.

Central earthing point (CEP) and main earthing busbar (MEB)

When voltage sources, which are located far apart, are earthed, for example secondary unit substation and standby generator set, the separate earthing of their neutral points results in compensating currents through foreign conductive building structures. Undesired electro-magnetic interference is created, caused by the building currents on the one hand and the lack of summation current in the respective cables on the other.

If the requirement is parallel operation of several voltage sources and if building currents shall be reduced as far as possible, the preferable technical solution is implementing the central earthing point (CEP). In this case, the neutral points of all voltage sources are connected to the system protective conductor / system earth at a single point only. The effect is that despite potential differences of the neutral points, building currents cannot be formed any more.

Tab. 2/8: Cubicle widths for earthing short-circuit points

Earthing and short-circuit points	Cubicle widths
Short-circuiting and earthing devices (SED)	400 mm (200 mm as cubicle extension)
Central earthing point (CEP)	600 mm, 1,000 mm (200 mm as cubicle extension)
Main earthing busbar (MEB)	600 mm, 1,000 mm

The central earthing point can only be used in the power supply system L1, L2, L3, PEN (insulated) + PE. To implement the central earthing point (CEP) - with or without a main earthing busbar (MEB) - a cubicle for customized solutions is inserted (see Chapter 6.3 "Cubicle for customized solutions").

CEP design

The CEP is designed as a bridge between the separately wired (insulated) PEN and the PE conductor of the switchboard. Measuring current transformers can be mounted on the bridge for residual current measurements. In order to be able to remove the current transformer in case of a defect, a second, parallel bridge is provided. This prevents cancelling the protective measure due to a missing connection between the separately wired PEN and PE conductor.

A mounting plate in the cubicle is provided for placing the residual-current monitors. The cubicle widths are given in Tab. 2/8.

MEB design

In addition to the central earthing point, the MEB can optionally be mounted as a horizontal bar. This connecting bar is separately installed in the cubicle and rigidly connected to the PE conductor. Depending on how the cable is entered, the MEB is installed at the top or bottom of the cubicle. The cubicle widths can be found in Tab. 2/8 and information about the cable terminals can be found in Tab. 2/9.

Tab. 2/9: Cable terminal for the main earthing busbar

Cubicle width	Max. number of cables connectible with cable lug DIN 46235 (screw)
600 mm	10 x 185 mm ² (M10) + 12 x 240 mm ² (M12) ¹⁾
1,000 mm	20 x 185 mm ² (M10) + 22 x 240 mm ² (M12) ¹⁾
¹⁾ 300 mm ² cable lugs can be used with M12 screw, but this cable lug does not comply with DIN 46235, although it is supplied by some manufacturers.	

2.5 Overview of mounting designs

Tab. 2/10: Basic data of the different mounting designs



	Circuit-breaker design	Universal mounting design	In-line design, plug-in
Mounting design	Withdrawable design Fixed mounted design	Withdrawable design Fixed-mounted design with compartment doors Plug-in design	Plug-in design
Functions	Incoming unit Outgoing unit Coupler	Cable feeders Motor feeders (MCC)	Cable feeders
Rated current I_n	Up to 6,300 A	Up to 630 A	Up to 630 A
Connection type	Front and rear side	Front and rear side	Front side
Cubicle width	400, 600, 800, 1,000, 1,400 mm	600, 1,000, 1,200 mm	1,000, 1,200 mm
Internal separation	Form 1, 2b, 3a, 4b, 4 type 7 (BS)	Form 3b, 4a, 4b, 4 type 7 (BS)	Form 3b, 4b
Busbar position	Rear, top	Rear, top	Rear, top



1

2

3

4

5

6

7

8

9

10

11

Fixed-mounted design	In-line design, fixed-mounted	Reactive power compensation
Fixed-mounted design with front covers	Fixed mounted design	Fixed mounted design
Cable feeders	Cable feeders	Central compensation of reactive power
Up to 630 A	Up to 630 A	Non-choked up to 600 kvar Choked up to 500 kvar
Front side	Front side	Front side
1,000, 1,200 mm	600, 800, 1,000 mm	800 mm
Form 1, 2b, 3b, 4a, 4b	Form 1, 2b	Form 1, 2b
Rear, top	Rear	Rear, top, without



Chapter 3

Circuit-breaker design

3.1	Cubicles with one ACB (3WL)	24
3.2	Cubicles with up to three ACB (3WL)	29
3.3	Cubicles with one MCCB (3VL)	30
3.4	Cubicles for direct supply and direct feeder	31

3 Circuit-breaker design

The cubicles for 3W. and 3V. circuit-breakers ensure both personal safety and long-term operational safety (Fig. 3/1). The incoming, outgoing and coupling units in circuit-breaker design are equipped with 3W. air circuit-breakers (ACB) in withdrawable or fixed-mounted design or alternatively with 3V. moulded-case circuit-breakers (MCCB) (Tab. 3/1).

The cubicle dimensions are tailored to the circuit-breaker sizes and can be selected according to the individual requirements. The circuit-breaker design provides optimal connect conditions for every nominal current range. In addition to cable connections, the system also provides design-verified connections to SIVACON 8PS busbar trunking systems.



Fig. 3/1: Cubicles in circuit-breaker design

Tab. 3/1: General cubicle characteristics in circuit-breaker design

Application range	- Incoming circuit-breakers - Coupling circuit-breakers (longitudinal and transverse couplers) - Outgoing circuit-breakers - Direct incoming/outgoing feeders (without circuit-breakers)	
Degrees of protection	- Up to IP43 - IP54	Ventilated Non-ventilated
Form of internal separation	- Form 1, 2b - Form 3a, 4b ¹⁾	Door cubicle high Door divided in 3 parts
Design options	- Air circuit-breaker (ACB) in fixed-mounted or withdrawable design ²⁾ - Moulded-case circuit-breaker (MCCB) in fixed-mounted design ³⁾	
¹⁾ Also form 4b type 7 in acc. with BS EN 61439-2 possible ²⁾ Information about 3WT circuit-breakers is available from your Siemens contact ³⁾ Information about moulded-case circuit-breakers in plug-in/withdrawable design is available from your Siemens contact		

The circuit-breaker cubicles allow the installation of a current transformer (L1, L2 and L3) at the customer connection side. Information about the installation of additional transformers is available from your Siemens contact.

Cubicle with forced cooling

The circuit-breaker cubicles with forced cooling are equipped with fans (Fig. 3/2). Controlled fans are installed in the cubicle front below the circuit-breaker. The forced cooling makes for an increase of the rated current of the circuit-breaker cubicle. The other cubicle characteristics are identical to the cubicle without forced cooling.

The fan control comes completely configured. No further settings are required upon start-up of the switchboard. The fans are dimensioned such that the required cooling is still ensured if a fan fails. Failure of the fan or non-permissible temperature rises are signalled. Forced cooling is available for selected ACB (3WL) in withdrawable design.

The use of fans brings about additional noise emission. Under normal operating conditions, the noise emission may be 85 dB at the maximum. Higher noise emissions only occur in the case of a fault.

Observing local regulations on noise protection and occupational safety and health is mandatory. Rating data for cubicles with forced cooling is available from your Siemens contact.

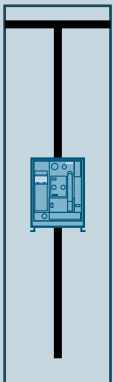
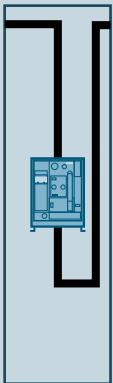

Fig. 3/2: Forced cooling in a circuit-breaker cubicle

3.1 Cubicles with one ACB (3WL)

The widths for the different cubicle types are listed by ACB type in Tab. 3/2 to Tab. 3/4.

Tab. 3/2: Cubicle dimensions for top busbar position

Cubicle type	ACB type	Nominal device current	Cubicle width in mm			
			Cable connection		Busbar connection	
			3-pole	4-pole	3-pole	4-pole
Incoming / outgoing unit						
 <p>Top busbar position, cable / busbar entry from the top or bottom</p>	3WL1106	630 A	400/600	600	-	-
	3WL1108	800 A	400/600	600	-	-
	3WL1110	1,000 A	400/600	600	-	-
	3WL1112	1,250 A	400/600	600	-	-
	3WL1116	1,600 A	400/600	600	400/600	600
	3WL1120	2,000 A	400/600	600	400/600	600
	3WL1220	2,000 A	600/800	800	600/800	800
	3WL1225	2,500 A	600/800	800	600/800	800
	3WL1232	3,200 A	600/800	800	600/800	800
	3WL1340	4,000 A ²⁾	800	1,000	800	1,000
	3WL1350 ¹⁾	5,000 A ²⁾	-	-	1,000	1,000
	3WL1363 ¹⁾	6,300 A ²⁾	-	-	1,000	1,000
The position of the connecting bars is identical for cable entry from the top or bottom						
Longitudinal coupler			3-pole	4-pole		
 <p>Top busbar position</p>	3WL1106	630 A	600	800	-	-
	3WL1108	800 A	600	800	-	-
	3WL1110	1,000 A	600	800	-	-
	3WL1112	1,250 A	600	800	-	-
	3WL1116	1,600 A	600	800	-	-
	3WL1120	2,000 A	600	800	-	-
	3WL1220	2,000 A	800	1,000	-	-
	3WL1225	2,500 A	800	1,000	-	-
	3WL1232	3,200 A	800	1,000	-	-
	3WL1340	4,000 A ²⁾	1,000	1,200	-	-
	3WL1350 ¹⁾	5,000 A ²⁾	1,200	1,200	-	-
	3WL1363 ¹⁾	6,300 A ²⁾	1,200	1,200	-	-

¹⁾ Withdrawable design, frame height 2,200 mm

²⁾ Main busbar up to 6,300 A

Tab. 3/3: Cubicle dimensions for rear busbar position

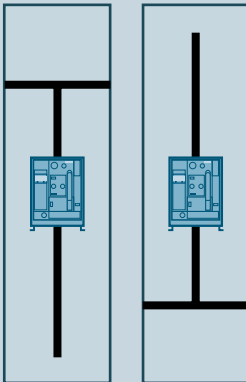
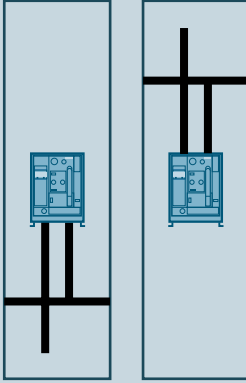
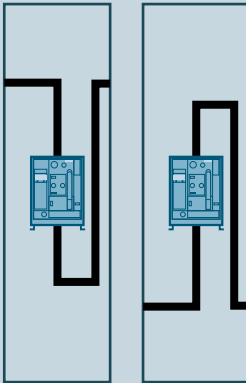
Cubicle type	ACB type	Nominal device current	Cubicle width in mm			
			Cable connection		Busbar connection	
			3-pole	4-pole	3-pole	4-pole
 <p>1 busbar system in the cubicle: rear top busbar position and cable / busbar entry from the bottom or rear bottom busbar position and cable / busbar entry from the top</p>	3WL1106	630 A	400/600	600	-	-
	3WL1108	800 A	400/600	600	-	-
	3WL1110	1,000 A	400/600	600	-	-
	3WL1112	1,250 A	400/600	600	-	-
	3WL1116	1,600 A	400/600	600	400/600	600
	3WL1120	2,000 A	400/600	600	400/600	600
	3WL1220	2,000 A	600/800	800	600/800	800
	3WL1225	2,500 A	600/800	800	600/800	800
	3WL1232	3,200 A	600/800	800	600/800	800
	3WL1340	4,000 A	1,000	1,000	800 ¹⁾ /1,000	1,000
	3WL1350 ¹⁾	5,000 A ²⁾	-	-	1,000	1,000
	3WL1363 ¹⁾	6,300 A ²⁾	-	-	1,000	1,000
	 <p>1 busbar system in the cubicle: rear bottom busbar position and cable / busbar entry from the bottom or rear top busbar position and cable / busbar entry from the top</p>	3WL1106	630 A	400/600	600	-
3WL1108		800 A	400/600	600	-	-
3WL1110		1,000 A	400/600	600	-	-
3WL1112		1,250 A	400/600	600	-	-
3WL1116		1,600 A	400/600	600	400/600	600
3WL1120		2,000 A	400/600	600	400/600	600
3WL1220		2,000 A	600/800	800	600/800	800
3WL1225		2,500 A	600/800	800	600/800	800
3WL1232		3,200 A	600/800	800	600/800	800
3WL1340		4,000 A	-	-	800 ³⁾ /1,000	1,000
Longitudinal coupler			3-pole	4-pole		
	 <p>1 busbar system in the cubicle: rear top busbar position or rear bottom busbar position</p>	3WL1106	630 A	600	600	-
3WL1108		800 A	600	600	-	-
3WL1110		1,000 A	600	600	-	-
3WL1112		1,250 A	600	600	-	-
3WL1116		1,600 A	600	600	-	-
3WL1120		2,000 A	600	600	-	-
3WL1220		2,000 A	800	800	-	-
3WL1225		2,500 A	800	1,000	-	-
3WL1232		3,200 A	800	1,400	-	-
3WL1340		4,000 A	1,000	1,000	-	-
3WL1350 ¹⁾		5,000 A ²⁾	1,400	1,400	-	-
3WL1363 ¹⁾	6,300 A ²⁾	1,400	1,400	-	-	

¹⁾ Withdrawable design, frame height 2,200 mm

²⁾ Main busbar up to 7,010 A

³⁾ Frame height 2,200 mm

1
2
3
4
5
6
7
8
9
10
11

Tab. 3/4: Cubicle dimensions for rear busbar position with two busbar systems in the cubicle

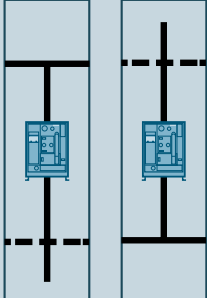
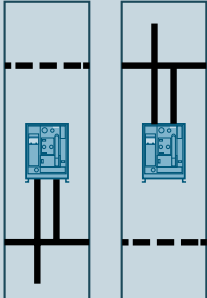
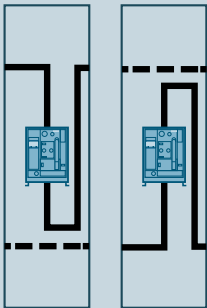
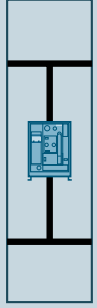
Cubicle type	ACB type	Nominal device current	Cubicle width in mm			
			Cable connection		Busbar connection	
			3-pole	4-pole	3-pole	4-pole
 <p>2 busbar systems in the cubicle: rear top busbar position and cable / busbar entry from the bottom</p> <p>or</p> <p>rear bottom busbar position and cable / busbar entry from the top</p>	3WL1106	630 A	400/600	600	-	-
	3WL1108	800 A	400/600	600	-	-
	3WL1110	1,000 A	400/600	600	-	-
	3WL1112	1,250 A	400/600	600	-	-
	3WL1116	1,600 A	400/600	600	400/600	600
	3WL1120	2,000 A	400/600	600	400/600	600
	3WL1220	2,000 A	600/800	800	600/800	800
	3WL1225	2,500 A	600/800	800	600/800	800
	3WL1232	3,200 A	600/800	800	600/800	800
	3WL1340	4,000 A	1,000	1,000	800 ¹⁾ /1,000	1,000
 <p>2 busbar systems in the cubicle: rear bottom busbar position and cable / busbar entry from the bottom</p> <p>or</p> <p>rear top busbar position and cable / busbar entry from the top</p>	3WL1106	630 A	400/600	600	-	-
	3WL1108	800 A	400/600	600	-	-
	3WL1110	1,000 A	400/600	600	-	-
	3WL1112	1,250 A	400/600	600	-	-
	3WL1116	1,600 A	400/600	600	400/600	600
	3WL1120	2,000 A	400/600	600	400/600	600
	3WL1220	2,000 A	600/800	800	600/800	800
	3WL1225	2,500 A	600/800	800	600/800	800
	3WL1232	3,200 A	600/800	800	600/800	800
	3WL1340	4,000 A	-	-	800 ¹⁾ /1,000	1,000
Longitudinal coupler			3-pole	4-pole		
 <p>2 busbar systems in the cubicle: rear top busbar position</p> <p>or</p> <p>rear bottom busbar position</p>	3WL1106	630 A	600	600	-	-
	3WL1108	800 A	600	600	-	-
	3WL1110	1,000 A	600	600	-	-
	3WL1112	1,250 A	600	600	-	-
	3WL1116	1,600 A	600	600	-	-
	3WL1120	2,000 A	600	600	-	-
	3WL1220	2,000 A	800	800	-	-
	3WL1225	2,500 A	800	800	-	-
	3WL1232	3,200 A	800	800	-	-
	3WL1340	4,000 A	1,000	1,000	-	-
Transverse coupler			3-pole	4-pole		
 <p>2 busbar systems in the cubicle: rear top busbar position and rear bottom busbar position</p>	3WL1106	630 A	400/600	600	-	-
	3WL1108	800 A	400/600	600	-	-
	3WL1110	1,000 A	400/600	600	-	-
	3WL1112	1,250 A	400/600	600	-	-
	3WL1116	1,600 A	400/600	600	-	-
	3WL1120	2,000 A	400/600	600	-	-
	3WL1220	2,000 A	600/800	800	-	-
	3WL1225	2,500 A	600/800	800	-	-
	3WL1232	3,200 A	600/800	800	-	-
3WL1340	4,000 A	1,000	1,000	-	-	

¹⁾ Frame height 2,200 mm

Cable and busbar connection

The number of connectible cables, as stated in Tab. 3/5, may be restricted by the available roof/floor panel openings and/or door installations. The position of the connecting bars is identical for front or rear connection in the cubicle.

Connection to the SIVACON 8PS busbar trunking system is effected by means of an installed busbar trunking connector. The SIVACON S8 connecting system is located completely within the cubicle. The busbars can be connected both from the top and from the bottom, thus allowing flexible connection. The factory-provided copper plating guarantees high short-circuit strength, which is verified by a design test, as is the temperature rise limits.

Short-circuiting and earthing device (SED)

For short-circuiting and earthing, short-circuiting and earthing devices (SED) are available for the circuit-breaker cubicle. Suitable mounting points are affixed to the points to be earthed, which ease SED installation.

Tab. 3/5: Cable connection for cubicles with 3WL

Cable lug DIN 46235 (240 mm ² , M12) ¹⁾	Max. number of cables connectible per phase dependent on breaker size				
	3WL11 up to 1,000 A	3WL11 1,250 to 2,000 A	3WL12 up to 1,600 A	3WL12 2,000 to 3,200 A	3WL13 ²⁾ up to 4,000 A
	4	6	6	12	14
¹⁾ It is possible to use 300 mm ² cable lugs with a M12 screw, but this cable lug is not in compliance with DIN 46235, although it is supplied by some manufacturers					
²⁾ 5,000 A and 6,300 A circuit-breakers with busbar connection					

1

2

3

4

5

6

7

8

9

10

11

Rated currents

Tab. 3/6 states the rated currents for the different configurations dependent on the cubicle type.

Tab. 3/6: Rated currents for cubicles with one 3WL

ACB type	Nominal device current	Rated current at 35 °C ambient temperature					
		Top busbar position			Rear busbar position		
		Cable connection		Cable entry from the bottom		Cable entry from the top	
		Non-ventilated	Ventilated	Non-ventilated	Ventilated	Non-ventilated	Ventilated
3WL1106	630 A	630 A	630 A	630 A	630 A	630 A	630 A
3WL1108	800 A	800 A	800 A	800 A	800 A	800 A	800 A
3WL1110	1,000 A	930 A	1,000 A	1,000 A	1,000 A	1,000 A	1,000 A
3WL1112	1,250 A	1,160 A	1,250 A	1,170 A	1,250 A	1,020 A	1,190 A
3WL1116	1,600 A	1,200 A	1,500 A	1,410 A	1,600 A	1,200 A	1,360 A
3WL1120	2,000 A	1,550 A	1,780 A	1,500 A	1,840 A	1,480 A	1,710 A
3WL1220	2,000 A	1,630 A	2,000 A	1,630 A	1,920 A	1,880 A	2,000 A
3WL1225	2,500 A	1,960 A	2,360 A	1,950 A	2,320 A	1,830 A	2,380 A
3WL1232	3,200 A	2,240 A	2,680 A	2,470 A	2,920 A	1,990 A	2,480 A
3WL1340	4,000 A	2,600 A	3,660 A	2,700 A	3,700 A	2,430 A	3,040 A
ACB type	Nominal device current	Top busbar position					
		Busbar entry from the bottom, SIVACON 8PS system LD or LX		Busbar entry from the top, SIVACON 8PS system LD		Busbar entry from the top, SIVACON 8PS system LX	
		Non-ventilated	Ventilated	Non-ventilated	Ventilated	Non-ventilated	Ventilated
		3WL1116	1,600 A	1,200 A	1,500 A	1,420 A	1,580 A
3WL1120	2,000 A	1,550 A	1,780 A	1,600 A	1,790 A	1,360 A	1,630 A
3WL1220	2,000 A	1,630 A	2,000 A	1,630 A	2,000 A	1,630 A	2,000 A
3WL1225	2,500 A	1,960 A	2,360 A	2,030 A	2,330 A	1,820 A	2,310 A
3WL1232	3,200 A	2,240 A	2,680 A	2,420 A	2,720 A	2,090 A	2,640 A
3WL1340	4,000 A	2,600 A	3,660 A	2,980 A	3,570 A	3,480 A	3,820 A
3WL1350	5,000 A	3,830 A	4,450 A	3,860 A	4,460 A	3,830 A	4,450 A
3WL1363	6,300 A	4,060 A ¹⁾	4,890 A ¹⁾	-	-	4,530 A	5,440 A
ACB type	Nominal device current	Rear busbar position					
		Busbar entry from the bottom, SIVACON 8PS system LD or LX		Busbar entry from the top, SIVACON 8PS system LD		Busbar entry from the top, SIVACON 8PS system LX	
		Non-ventilated	Ventilated	Non-ventilated	Ventilated	Non-ventilated	Ventilated
		3WL1116	1,600 A	1,410 A	1,600 A	1,440 A	1,550 A
3WL1120	2,000 A	1,500 A	1,840 A	1,590 A	1,740 A	1,310 A	1,570 A
3WL1220	2,000 A	1,630 A	1,920 A	1,630 A	1,920 A	1,660 A	1,970 A
3WL1225	2,500 A	1,950 A	2,320 A	2,130 A	2,330 A	1,940 A	2,230 A
3WL1232	3,200 A	2,470 A	2,920 A	2,440 A	2,660 A	2,160 A	2,530 A
3WL1340	4,000 A	2,700 A	3,700 A	2,750 A	3,120 A	2,700 A	3,110 A
3WL1350	5,000 A	3,590 A	4,440 A	3,590 A	4,440 A	3,580 A	4,490 A
3WL1363	6,300 A	3,710 A ¹⁾	4,780 A ¹⁾	-	-	3,710 A	4,780 A
ACB type	Nominal device current	Top busbar position			Rear busbar position		
		Longitudinal coupler		Longitudinal coupler		Transverse coupler	
		Non-ventilated	Ventilated	Non-ventilated	Ventilated	Non-ventilated	Ventilated
		3WL1106	630 A	630 A	630 A	630 A	630 A
3WL1108	800 A	800 A	800 A	800 A	800 A	800 A	800 A
3WL1110	1,000 A	1,000 A	1,000 A	1,000 A	1,000 A	1,000 A	1,000 A
3WL1112	1,250 A	1,160 A	1,250 A	1,140 A	1,250 A	1,170 A	1,250 A
3WL1116	1,600 A	1,390 A	1,600 A	1,360 A	1,600 A	1,410 A	1,600 A
3WL1120	2,000 A	1,500 A	1,850 A	1,630 A	1,910 A	1,500 A	1,840 A
3WL1220	2,000 A	1,630 A	1,930 A	1,710 A	2,000 A	1,630 A	1,920 A
3WL1125	2,500 A	1,960 A	2,360 A	1,930 A	2,440 A	1,950 A	2,320 A
3WL1132	3,200 A	2,200 A	2,700 A	2,410 A	2,700 A	2,470 A	2,920 A
3WL1140	4,000 A	2,840 A	3,670 A	2,650 A	3,510 A	2,700 A	3,700 A
3WL1350	5,000 A	3,660 A	4,720 A	3,310 A	4,460 A	-	-
3WL1363	6,300 A	3,920 A	5,180 A	3,300 A	5,060 A	-	-

¹⁾ SIVACON 8PS system LX

3.2 Cubicles with up to three ACB (3WL)

To allow space-saving installation, cubicles with up to three circuit-breakers as incoming and/or outgoing circuit-breakers can be implemented for specific ACB types (3WL).

Cubicle dimensions and cable connection

In a cubicle with three circuit-breakers, the cables are connected from the rear. A variant with cable connection from the front does not offer any space advantages because of the required connection compartment. For this application, cubicles with one circuit-breaker are used. The three mounting slots can be designed independently of each other either with a circuit-breaker, as device compartment or as direct incoming feeder. Cubicle dimensions and information about the cable connection are given in Tab. 3/7 and Tab. 3/8. The number of connectible cables may be restricted by the available roof/floor panel openings and/or door installations.

Rated currents

The up to three circuit-breakers in the cubicle interact. Dependent on the utilisation of the individual circuit-breakers and the current distribution within the cubicle, different rated currents result for the individual circuit-breakers. Tab. 3/9 states the maximum rated currents for three concrete cases of current distribution in the cubicle:

- Variant A: same rated current for all three mounting slots
- Variant B: highest current for top mounting slot, lowest current for bottom mounting slot
- Variant C: highest current for bottom mounting slot, lowest current for top mounting slot

Information about an individual distribution of the rated currents in the cubicle is available from your Siemens contact.

Tab. 3/7: Dimensions for cubicles with three ACB of type 3WL

ACB type	Nominal device current	Cubicle width in mm		Cubicle depth in mm
		3-pole	4-pole	
3WL1106	630 A	600	600	800
3WL1108	800 A	600	600	800
3WL1110	1,000 A	600	600	800
3WL1112	1,250 A	600	600	1,200 ¹⁾
3WL1116	1,600 A	600	600	1,200 ¹⁾

¹⁾ Main busbar up to 6,300 A

Frame height for cubicles with up to three ACB is 2,200 mm.

Tab. 3/8: Cable connection in cubicles with up to three ACB

Cable lug DIN 46235 (240 mm ² , M12) ¹⁾	Max. number of cables connectible per phase dependent on cubicle depth	
	800 mm	1,200 mm
	4	6

¹⁾ It is possible to use 300 mm² cable lugs with a M12 screw, but this cable lug is not in compliance with DIN 46235, although it is supplied by some manufacturers.

Tab. 3/9: Rated currents for special load cases of a circuit-breaker cubicle with three 3WL11 circuit-breakers in the cubicle

Nominal device current	Cubicle depth	Mounting slot	Rated current at 35 °C ambient temperature					
			Variant A		Variant B		Variant C	
			Non-ventilated	Ventilated	Non-ventilated	Ventilated	Non-ventilated	Ventilated
Up to 1,000 A	800 mm	Top	710 A	960 A	900 A	1,000 A	0	900 A
		Center	710 A	955 A	905 A	1,000 A	980 A	1,000 A
		Bottom	710 A	955 A	0	905 A	925 A	1,000 A
Up to 1,600 A	1,200 mm	Top	1,030 A	1,350 A	1,220 A	1,600 A	305 A	910 A
		Center	1,030 A	1,350 A	1,230 A	1,600 A	1,200 A	1,440 A
		Bottom	1,040 A	1,350 A	231 A	300 A	1,310 A	1,600 A

3.3 Cubicles with one MCCB (3VL)

The widths for the different cubicle types are listed by MCCB type in Tab. 3/10. Information about cable connection and rated currents for the different configurations of

MCCB, busbar position, cable entry and ventilation conditions is given in Tab. 3/11 and Tab. 3/12.

Tab. 3/10: Widths for incoming/outgoing feeder cubicles with MCCB

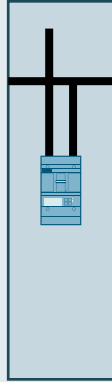
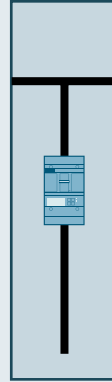
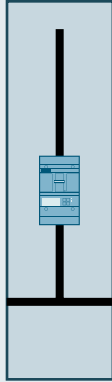
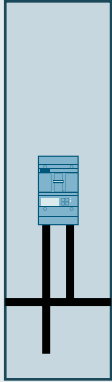
Cubicle widths for 3VL5763 (630 A), 3VL6780 (800 A), 3VL7712 (1,250 A), 3VL8716 (1,600 A)				
Top busbar position	Rear top busbar position		Rear bottom busbar position	
Cable entry from the top or bottom	Cable entry from the top	Cable entry from the bottom	Cable entry from the top	Cable entry from the bottom
				
The position of the connecting bars is identical for cable entry from the top or bottom	Two main busbar systems in the cubicle are also possible			
3-pole: cubicle width 400 mm	3-pole: cubicle width 400 mm			
4-pole: cubicle width 400 mm	4-pole: cubicle width 600 mm			

Tab. 3/11: Cable connection for cubicles with MCCB of type 3VL

Cable lug DIN 46235 (240 mm ² , M12) ¹⁾	Max. number of cables connectible per phase dependent on rated current	
	Up to 800 A	From 1,250 to 1,600 A
	4	6

¹⁾ It is possible to use 300 mm² cable lugs with an M12 screw (cable lug is not in compliance with DIN 46235, although it is available from some manufacturers)

Tab. 3/12: Rated currents for cubicles with 3VL

MCCB type	Nominal device current	Rated current at 35 °C ambient temperature					
		Top busbar position		Rear busbar position			
		Cable connection		Cable entry from the bottom		Cable entry from the top	
		Non-ventilated	Ventilated	Non-ventilated	Ventilated	Non-ventilated	Ventilated
3VL5763	630 A	540 A	570 A	515 A	570 A	475 A	520 A
3VL6780	800 A	685 A	720 A	655 A	720 A	605 A	660 A
3VL7712	1,250 A	890 A	1,100 A	890 A	1,100 A	775 A	980 A
3VL8716	1,600 A	900 A	1,100 A	1,050 A	1,200 A	915 A	1,070 A

3.4 Cubicles for direct supply and direct feeder

The different cubicle types:

1. Top busbar position, cable entry from the bottom or top (the position of the connecting bars is identical for cable entry from the top or bottom)
2. Rear top busbar position, cable entry from the top
3. Rear top busbar position, cable entry from the bottom
4. Rear bottom busbar position, cable entry from the top
5. Rear bottom busbar position, cable entry from the bottom

are schematized in Fig. 3/3.

The cubicle width and maximum number of cables which can be connected depend on the rated current (Tab. 3/13 and Tab. 3/14). The rated currents, in turn, depend on the busbar position and cable entry (Tab. 3/15).

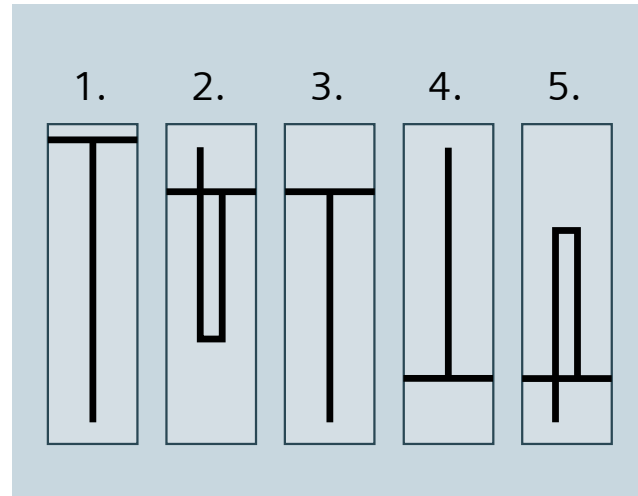

Fig. 3/3: Cubicle types for direct supply and direct feeder (refer to the text for explanations)

Tab. 3/13: Cubicle width for direct supply and direct feeder

Nominal current	1,000 A	1,600 A	2,500 A	3,200 A	4,000 A
Cubicle width	400 mm	400 mm	600 mm	600 mm	800 mm

Tab. 3/14: Cable connection for direct supply and direct feeder

Cable lug DIN 46235 (240 mm ² , M12) ¹⁾	Max. number of cables connectible per phase dependent on nominal current				
	1,000 A	1,600 A	2,500 A	3,200 A	4,000 A
	4	6	12	12	14

¹⁾ Using 300 mm² cable lugs with an M12 screw is possible. However, this cable lug is not in compliance with DIN 46235, although it is available at some manufacturers

The number of connectible cables may be restricted by the available roof/floor panel openings and/or door installations.

The position of the connection busbars is identical for front or rear connection in the cubicle.

Tab. 3/15: Rated currents for direct supply and direct feeder

Nominal current	Rated current at 35 °C ambient temperature					
	Top busbar position			Rear busbar position		
	Cable connection		Cable entry from the bottom		Cable entry from the top	
	Non-ventilated	Ventilated	Non-ventilated	Ventilated	Non-ventilated	Ventilated
1,000 A	905 A	1,050 A	1,100 A	1,190 A	1,120 A	1,280 A
1,600 A	1,300 A	1,500 A	1,530 A	1,640 A	1,480 A	1,740 A
2,500 A	1,980 A	2,410 A	2,230 A	2,930 A	2,210 A	2,930 A
3,200 A	2,340 A	2,280 A	2,910 A	3,390 A	2,770 A	3,390 A
4,000 A	3,430 A	4,480 A	3,300 A	4,210 A	3,140 A	4,210 A



Chapter 4

Universal mounting design

4.1	Fixed-mounted design with compartment door	37
4.2	In-line switch disconnectors with fuses (3NJ62 / SASIL plus)	38
4.3	Withdrawable design	38

4 Universal mounting design

The universal mounting design of SIVACON S8 switchboards (Fig. 4/1) allows outgoing feeders in withdrawable design, fixed-mounted design and plug-in in-line design to be implemented. A combination of these mounting

designs makes for a space-optimized structure of the switchboard. Tab. 4/1 gives an overview of the general cubicle characteristics.



Fig. 4/1: Cubicles for universal mounting design: on the left with front cable connection; on the right for rear cable connection

Tab. 4/1: General cubicle characteristics for the universal mounting design

Application range	<ul style="list-style-type: none"> - Incoming feeders up to 630 A - Outgoing cable feeders up to 630 A - Outgoing motor feeders up to 630 A 	
Degrees of protection	<ul style="list-style-type: none"> - Up to IP43 - IP54 	<ul style="list-style-type: none"> Ventilated Non-ventilated
Cubicle dimensions	<ul style="list-style-type: none"> - Cubicle height - Cubicle width (rear connection in cubicle) - Cubicle width (front connection in cubicle) 	<ul style="list-style-type: none"> 2,000, 2,200 mm 600 mm 1,000, 1,200 mm
Device compartment	<ul style="list-style-type: none"> - Height - Width 	<ul style="list-style-type: none"> 1,600, 1,800 mm 600 mm
Form of internal separation	<ul style="list-style-type: none"> - Up to form 4b ¹⁾ 	<ul style="list-style-type: none"> Compartment door, functional compartment door
Mounting designs	<ul style="list-style-type: none"> - Withdrawable design - Fixed-mounted design with compartment door - In-line switch-disconnectors 3NJ62 with fuses ²⁾ - In-line switch-disconnectors SASIL plus with fuses (Jean Müller) ²⁾ 	
¹⁾ Dependent on mounting design ²⁾ Front connection in cubicle		

Cubicle with forced cooling

Cubicles with forced cooling (Fig. 4/2) serve for the assembly of functional units with a very high power loss, for example, for withdrawable units with a frequency converter up to 45 kW.

On the left, the cubicles are equipped with a 100 mm wide ventilation duct. The width of the cable connection compartment is reduced by 100 mm so that the cubicle width does not change as compared to a cubicle without forced cooling.

The withdrawable units with forced cooling are equipped with fans. The fan control comes completely configured. No further settings are required upon start-up of the switchboard. The fans are dimensioned such that the second fan can ensure the required cooling of the withdrawable unit if a fan fails. A failure message will be issued.

The cubicles with forced cooling comply with degree of protection IP31. Connection is effected at the front of the cubicle.

The other cubicle characteristics are identical to the cubicle without forced cooling. All mounting designs and functional units without forced cooling can be applied.



Fig. 4/2: Cubicle with forced cooling for universal mounting design

1

2

3

4

5

6

7

8

9

10

11

Combination of mounting designs

The different mounting designs can be combined in a cubicle as shown in Fig. 4/3.

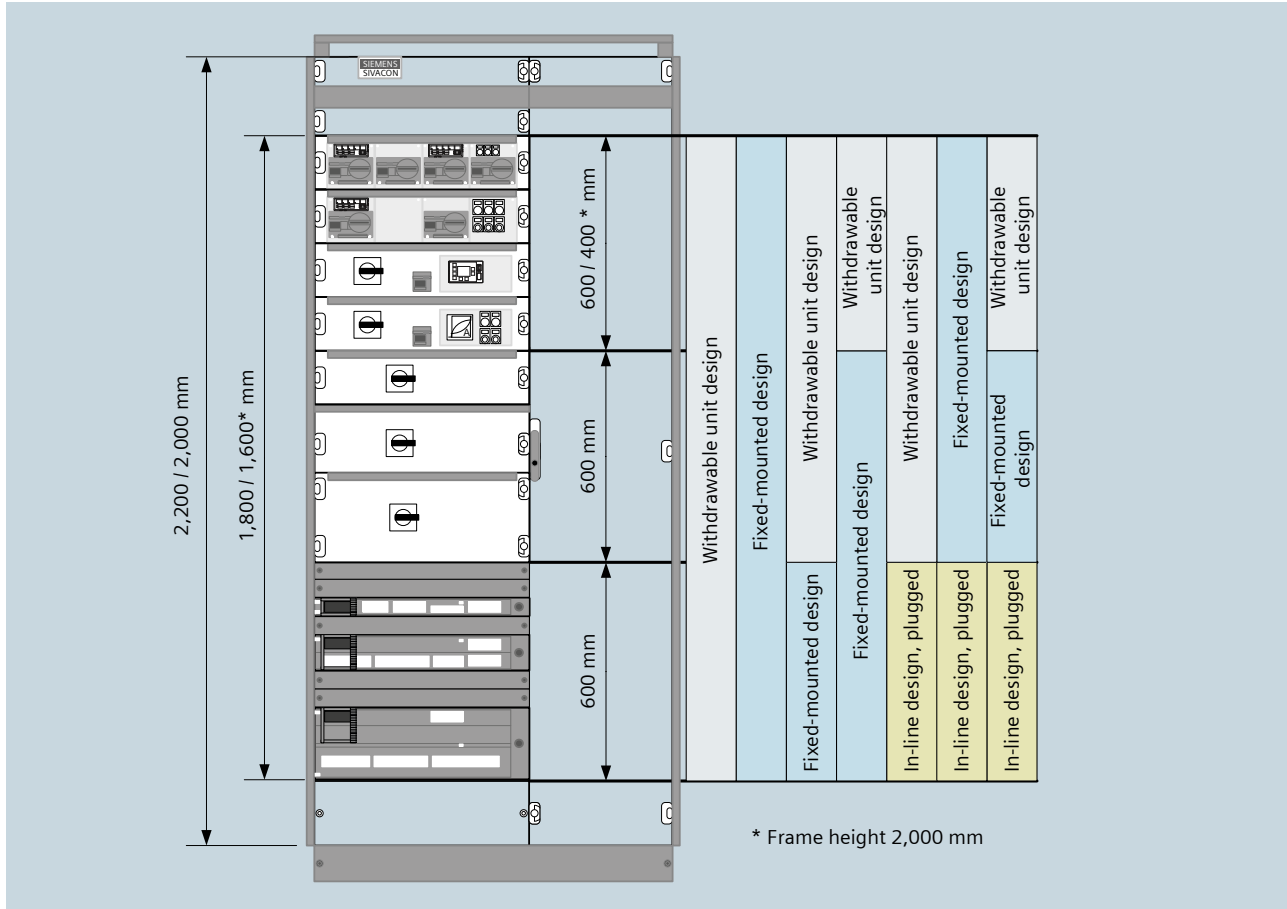

Fig. 4/3: Combination options for universal mounting design

Vertical distribution busbar

The vertical distribution busbars with the phase conductors L1, L2, L3 are arranged on the left at the back of the cubicle. The PE, N or PEN busbars are arranged in the cable

connection compartment. In the case of 4-pole feeders, the N conductor is allocated to the phase conductors L1, L2, L3 at the back of the cubicle. Ratings are stated in Tab. 4/2.

Tab. 4/2: Ratings of the vertical distribution busbar

Distribution busbar		Profile bar		Flat copper ¹⁾	
Cross section		400 mm ²	650 mm ²	1 x (40 mm x 10 mm)	2 x (40 mm x 10 mm)
Rated current at 35 °C ambient temperature	Ventilated	905 A	1,100 A	865 A	1,120 A
	Non-ventilated	830 A	1,000 A	820 A	1,000 A
Rated short-time withstand current I_{cw} (1 sec) ²⁾		65 kA	65 kA	65 kA	65 kA

¹⁾ Top main busbar position
²⁾ Rated conditional short-circuit current $I_{cc} = 150$ kA

4.1 Fixed-mounted design with compartment door

In fixed-mounted design, the switching devices are installed on mounting plates. They can be equipped with circuit-breakers or switch-disconnectors with fuses (Fig. 4/4; left). Tab. 4/3 gives an overview of the cubicle characteristics in fixed-mounted design. The incoming sides are connected to the vertical distribution busbars.

For forms 2b and 4a without current measurement, cables are connected directly at the switching device. The maximum cross sections that can be connected are stated in the device catalogues. For forms 3b and 4b as well as for feeders with current measurement (transformers), the cables are connected in the cable connection compartment (Fig. 4/4; right). The maximum connection cross sections are stated in Tab. 4/4.

The rating for cable feeders is stated in Tab. 4/5. The thermal interaction of the feeders in the cubicle has to be and is considered by specifying the rated diversity factor (RDF): Permissible continuous operational current (cable feeder) = rated current I_{nc} x RDF

For the feeders in the cubicle, the rated diversity factor RDF = 0.8 can be applied:

- regardless of the number of feeders in the cubicle
- regardless of the mounting position in the cubicle

For cubicles with a very high packing and/or power density, a project-specific assessment is recommended. Further information is available from your Siemens contact.



Fig. 4/4: Equipment in fixed-mounted design (left) and connection terminals in the cable connection compartment (right)

Tab. 4/3: Cubicle characteristics for the fixed-mounted design

Application range	- Incoming feeders up to 630 A - Outgoing cable feeders up to 630 A
Form of internal separation	- Form 2b Functional compartment door - Form 3b, 4a, 4b ¹⁾ Compartment door
Mounting designs	- Fixed-mounted module in compartment - Empty compartment, device compartment
¹⁾ Also form 4b type 7 in acc. with BS EN 61439-2 possible	

Tab. 4/4: Connection cross sections in fixed-mounted cubicles with a front door

Nominal feeder current	Max. connection cross section
≤ 250 A	120 mm ²
> 250 A	240 mm ²

Tab. 4/5: Ratings for cable feeders

Type	Nominal device current	Module height		Rated current I_{nc} at 35 °C ambient temperature	
		3-pole	4-pole	Non-ventilated	Ventilated
Fuse switch-disconnectors ¹⁾					
3NP1123	160 A	150 mm	-	106 A	120 A
3NP1133	160 A	150 mm	-	123 A	133 A
3NP1143	250 A	250 mm	-	222 A	241 A
3NP1153	400 A	300 mm	-	350 A	375 A
3NP1163	630 A	350 mm	-	480 A	530 A
3NP4010	160 A	150 mm	-	84 A	96 A
3NP4070	160 A	150 mm	-	130 A	142 A
3NP4270	250 A	250 mm	-	248 A	250 A
3NP4370	400 A	300 mm	-	355 A	370 A
3NP4470	630 A	350 mm	-	480 A	515 A
3NP5060	160 A	150 mm	-	130 A	142 A
3NP5260	250 A	250 mm	-	248 A	250 A
3NP5360	400 A	300 mm	-	355 A	370 A
3NP5460	630 A	350 mm	-	480 A	515 A
Switch-disconnectors with fuses ¹⁾					
3KL50	63 A	150 mm	250 mm	61 A	63 A
3KL52	125 A	250 mm	250 mm	120 A	125 A
3KL53	160 A	250 mm	250 mm	136 A	143 A
3KL55	250 A	300 mm	350 mm	250 A	250 A
3KL57	400 A	300 mm	350 mm	345 A	355 A
3KL61	630 A	450 mm	500 mm	535 A	555 A
Circuit-breakers					
3RV2.1	16 A	150 mm	-	12.7 A	14.1 A
3RV2.2	40 A	150 mm	-	27 A	31.5 A
3RV2.3	52 A	150 mm	-	39 A	40.5 A
3RV1.4	100 A	150 mm	-	71 A	79 A
3VL1	160 A	150 mm	200 mm	121 A	151 A
3VL2	160 A	150 mm	200 mm	130 A	158 A
3VL3	250 A	200 mm	250 mm	248 A	250 A
3VL4	400 A	250 mm	300 mm	400 A	400 A
3VL5	630 A	250 mm	350 mm	525 A	565 A
3VA10	100 A	150 mm	200 mm	72 A	85 A
3VA11	160 A	150 mm	200 mm	112 A	125 A
3VA12	250 A	150 mm	200 mm	232 A	246 A
3VA20	100 A	150 mm	200 mm	100 A	100 A
3VA21	160 A	150 mm	200 mm	160 A	160 A
3VA22	250 A	150 mm	200 mm	201 A	226 A
3VA23	400 A	200 mm	250 mm	350 A	400 A
3VA24	630 A	200 mm	250 mm	410 A	495 A
Device compartments (usable overall depth 310 mm)					
	150 mm				
	200 mm				
	300 mm				
	400 mm				
	500 mm				
	600 mm				
¹⁾ Rated current with fuse link = nominal device current					

4.2 In-line switch-disconnectors with fuses (3NJ62 / SASIL plus)

For the cubicle in universal mounting design, an adapter is available that allows the installation of in-line switch-disconnectors with fuses. This adapter is mounted at the bottom of the cubicle. It occupies 600 mm in the cubicle's device compartment. An installation height of 500 mm is

available for the installation of in-line switch-disconnectors. The basic cubicle characteristics are stated in Tab. 4/6.

Further information about in-line switch-disconnectors with fuses can be found in Chapter Chapter 5.

Tab. 4/6: Cubicle characteristics for in-line switch-disconnectors

Application range	- Incoming feeders up to 630 A - Outgoing cable feeders up to 630 A	
Form of internal separation	- Form 3b, 4b	
Degree of protection	- Up to IP41	Ventilated
Cubicle dimensions	- Width (front connection in cubicle)	1,000, 1,200 mm

4.3 Withdrawable design

If fast replacement of functional units is required in order to prevent downtimes, the withdrawable design offers a safe and flexible solution. Regardless of whether small or normal withdrawable units are used, the size is optimally

adapted for the required performance. The patented withdrawable unit contact system has been designed to be user-friendly and wear-resistant. Tab. 4/7 lists typical cubicle characteristics of the withdrawable design.

Tab. 4/7: General cubicle characteristics for the withdrawable design

Application range	- Incoming feeders up to 630 A - Outgoing cable feeders up to 630 A - Outgoing motor feeders up to 630 A	
Form of internal separation	- Form 3b, 4b ¹⁾	Compartment door, compartment cover
Design options	- Withdrawable unit in compartment - Reserve compartment - Empty compartment, device compartment	
Design variants for feeders ²⁾ (see Fig. 4/5)	- Standard feature design (SFD) - High feature design (HFD)	

¹⁾ Also form 4b type 7 in acc. with BS EN 61439-2 possible

²⁾ Withdrawable unit variants SFD and HFD can be mixed within one cubicle

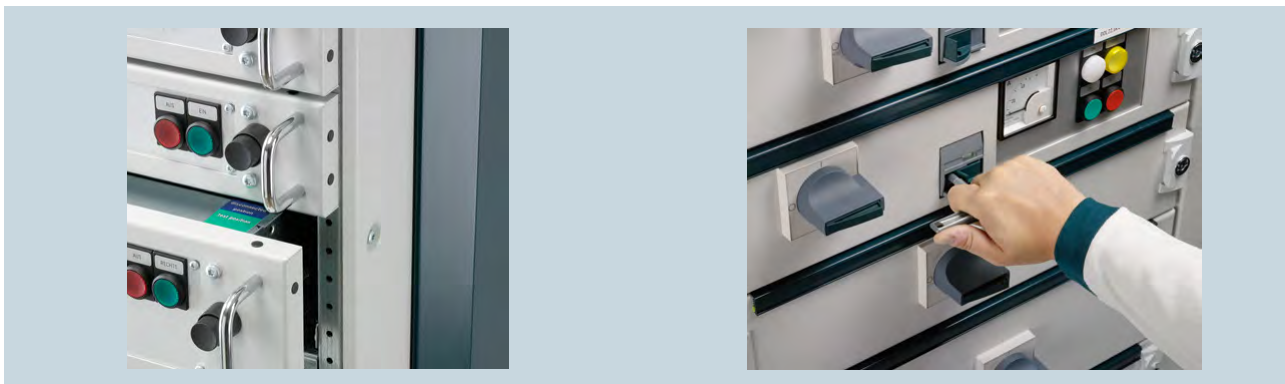

Fig. 4/5: Design variants of the withdrawable units in standard feature design (SFD; left) and high feature design (HFD; right)

4.3.1 Withdrawable design - standard feature design (SFD)

The withdrawable units provide a fixed contact system. Disconnected, test and connected position can be effected by moving the withdrawable unit (Fig. 4/6). In disconnected or test position, degree of protection IP30 is achieved. Moving the withdrawable unit under load is prevented by an operating error protection.

Withdrawable units in SFD provide a detachable cover. Controls and signalling devices are installed in an instrument panel and integrated into the withdrawable unit cover (Fig. 4/7). The contact system can be applied up to a rated current of 250 A. All withdrawable units are equipped with up to 40 auxiliary contacts. In SFD, normal withdrawable units with a withdrawable unit height of 100 mm or higher (grid size 50 mm) can be used. Tab. 4/8 summarizes the characteristics of withdrawable units in SFD.

Tab. 4/8: Characteristics of withdrawable units in SFD

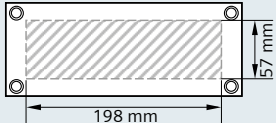
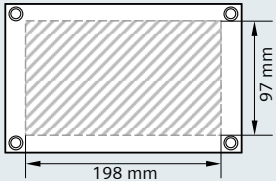
Mechanical withdrawable unit coding	
Withdrawable unit height 100 mm	15 coding options
Withdrawable unit height > 100 mm	21 coding options
Locking capability	
In "0" position for 3UC7 door coupling rotary drive	Up to 5 padlocks with a shackle diameter of 4.5 mm
	Up to 3 padlocks with a shackle diameter of 8.5 mm
Instrument panel	
Max. installation depth for devices	60 mm
Usable front area if withdrawable unit height 100 mm	
Usable front area if withdrawable unit height > 100 mm	
Withdrawable unit position signal	
With optional signalling switch (-S20)	Feeder available signal
	Test position signal
Communication interfaces	
PROFIBUS ¹⁾ (up to 12 Mbit/sec)	Via auxiliary contacts of the control plug
PROFINET ²⁾	Separate RJ45 plug
¹⁾ Apart from that, other protocols based on the EIA-485 (RS485) interface standard such as Modbus RTU can be used	
²⁾ Apart from that, other protocols based on the Industrial Ethernet standard such as Modbus/TCP can be used	

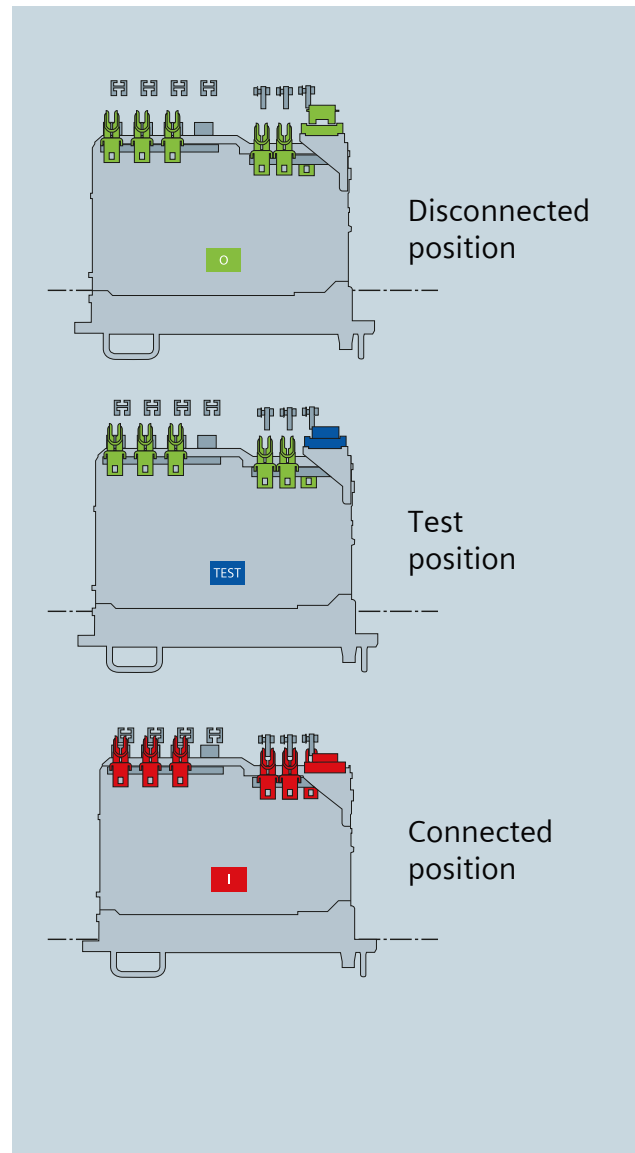

Fig. 4/6: Positions in the SFD contact system

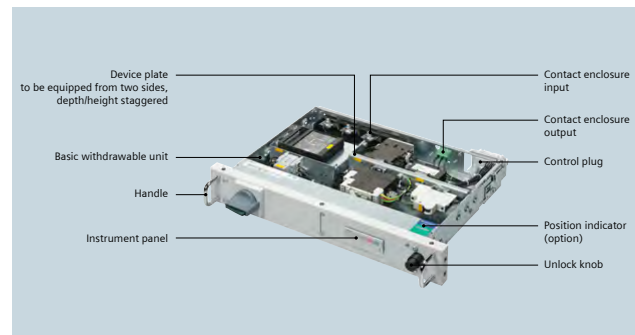

Fig. 4/7: Normal withdrawable unit in SFD with a withdrawable unit height of 100 mm

4.3.2 Withdrawable unit compartment in SFD

The vertical distribution busbar is covered test finger proofed (IP2X). Phase separation is possible. No connection work is required in the compartment (Fig. 4/8). The internal separation options up to form 4b lead to a high degree of personal safety. Connection is effected in a separate cable connection compartment. The connection data for main circuits are stated in Tab. 4/9, those for auxiliary circuits in Tab. 4/10 and the number of available auxiliary contacts in Tab. 4/11.

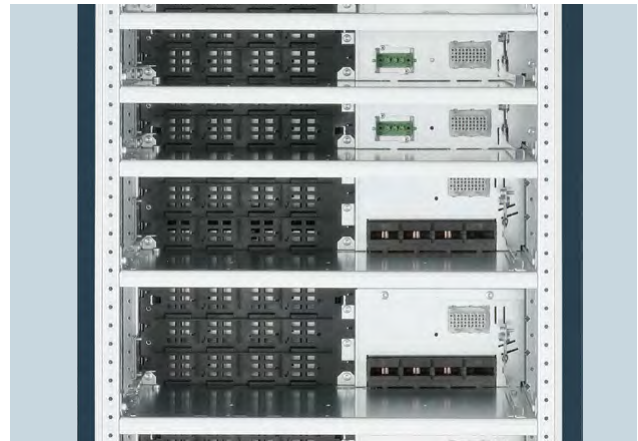

Fig. 4/8: Open withdrawable unit compartments in SFD

Tab. 4/9: Connection data for the main circuit

	Withdrawable unit height	Nominal feeder current	Terminal size	Maximum connection cross section
Front connection in cubicle	≥ 100 mm	≤ 35 A	16 mm ²	-
		≤ 63 A	35 mm ²	-
		≤ 120 A	70 mm ²	-
		≤ 160 A	95 mm ²	-
		≤ 250 A	150 mm ²	-
Rear connection in cubicle	100 mm	≤ 35 A	16 mm ²	-
	≥ 150 mm	≤ 250 A	-	1 x 185 mm ² 2 x 120 mm ²

Tab. 4/10: Connection data for the auxiliary circuit

Type	Terminal size
Push-in terminal connection	4 mm ²
Screw connection	6 mm ²

Tab. 4/11: Number of available auxiliary contacts for withdrawable units in SFD

Withdrawable unit height	Control plug type	Number of available auxiliary contacts (rated current 10 A / 250 V)		
		Without communication	With PROFIBUS	With PROFINET
≥ 100 mm	12-pole	12	9	12
	24-pole	24	21	24
≥ 150 mm	32-pole	32	29	-
	40-pole	40	37	-

4.3.3 Withdrawable design - high feature design (HFD)

The withdrawable units provide a mobile, wear-resistant contact system. Disconnected, test and connected position can be effected by moving the contacts without moving the withdrawable unit behind the closed compartment door (Fig. 4/10). Moving the contacts unit under load is prevented by an maloperation protection. The degree of protection is kept in every position. In the disconnected position, all withdrawable unit parts such as the contacts are located within the device contour and are protected against damage.

Withdrawable units are available as small withdrawable units (size 1/2 and 1/4, see Fig. 4/9 and Tab. 4/12) and as normal withdrawable units (Tab. 4/12). The withdrawable units of all sizes provide a uniform user interface.

In addition to the main switch, the individual positions can be locked. Controls and signalling devices are installed in an instrument panel. All withdrawable units are equipped with up to 40 auxiliary contacts.

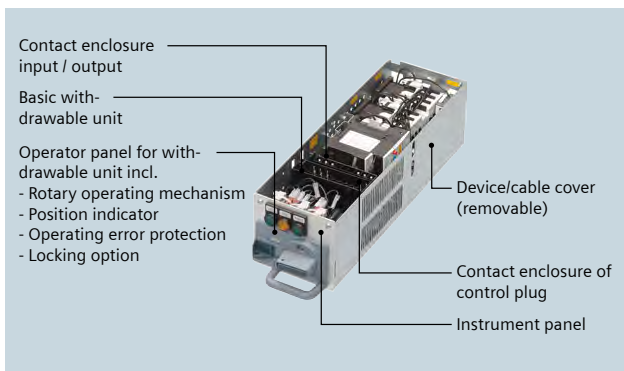

Fig. 4/9: Structure of a small withdrawable unit in HFD

Tab. 4/12: Withdrawable units in HFD

Type	Withdrawable unit height	View
Small withdrawable unit Width 1/4	150 mm, 200 mm	
Small withdrawable unit Width 1/2	150 mm, 200 mm	
Normal withdrawable unit	≥ 100 mm (grid 50 mm)	

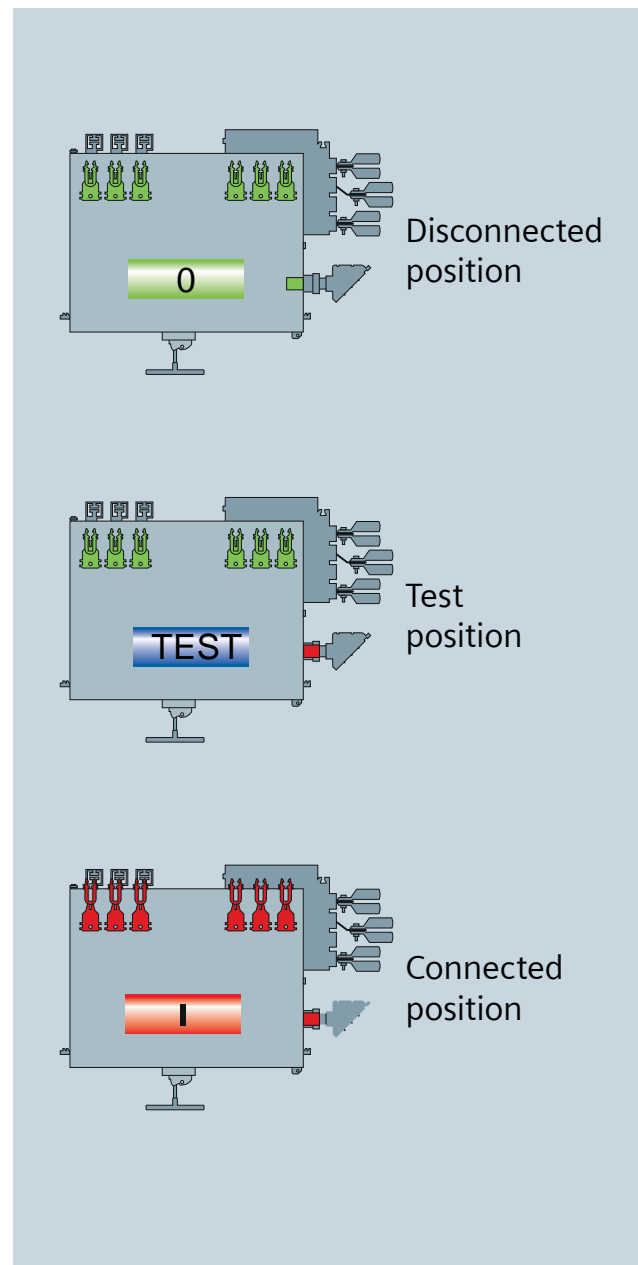

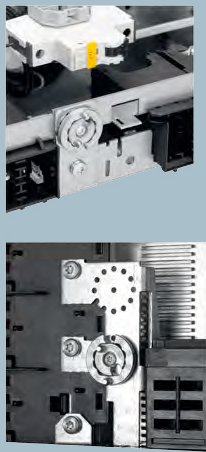

Fig. 4/10: Positions in the HFD contact system

1
2
3
4
5
6
7
8
9
10
11

Characteristics of the withdrawable units in HFD

Tab. 4/13 is subdivided into small and normal withdrawable units. The installation height has to be observed additionally. The mechanical coding of the compartments and withdrawable units prevents the exchanging of withdrawable units of identical size. The control and display devices for the feeder are installed in the instrument panel.

Tab. 4/13: Characteristics of the withdrawable units in HFD

	Small withdrawable unit	Normal withdrawable unit
Mechanical withdrawable unit coding		
	96 coding options (withdrawable unit height 150, 200 mm)	96 coding options (withdrawable unit height 100 mm)
		9,216 coding options (withdrawable unit height > 100 mm)
Locking capability		
	<p>The withdrawable units can be locked by means of a padlock with a shackle diameter of 6 mm. The withdrawable unit can then neither be moved to the disconnected, test or connected position nor be removed from the compartment.</p> <p>Locking capability of the main switch in the "0" position is integrated into the control unit: up to 3 padlocks with 4.5 mm Ø (shackle)</p>	<p>Locking capability for 3UC7 door coupling rotary drive in "0" position: up to 5 padlocks with 4.5 mm Ø (shackle) or up to 3 padlocks with 8.5 mm Ø (shackle)</p>
Instrument panel		
Maximum installation depth for devices	60 mm	70 mm
Usable front area	for installation height 150 mm see Fig. 4/11 for installation height 200 mm see Fig. 4/12	see Fig. 4/13
Withdrawable unit position signal		
With optional signalling switch (-S20)	Feeder available signal	Feeder available signal
	Test position signal	Test position signal
Communication interfaces		
PROFIBUS ¹⁾ (up to 12 Mbit/sec)	Via auxiliary contacts of the control plug	Via auxiliary contacts of the control plug
PROFINET ²⁾	Size ¼: One separate RJ45 plug	One or two separate RJ45 plug(s)
	Size ½: One or two separate RJ45 plug(s)	
<p>¹⁾ Apart from that, other protocols based on the EIA-485 (RS485) interface standard such as Modbus RTU can be used</p> <p>²⁾ Apart from that, other protocols based on the Industrial Ethernet standard such as Modbus TCP can be used</p>		

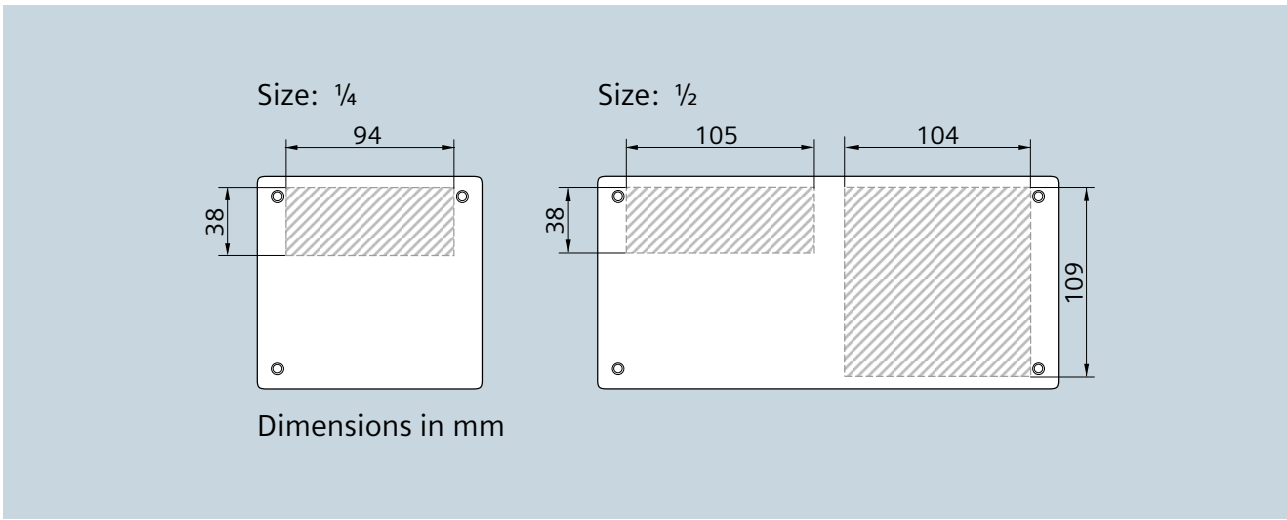

Fig. 4/11: Front areas usable for an instrument panel on small withdrawable units with an installation height of 150 mm

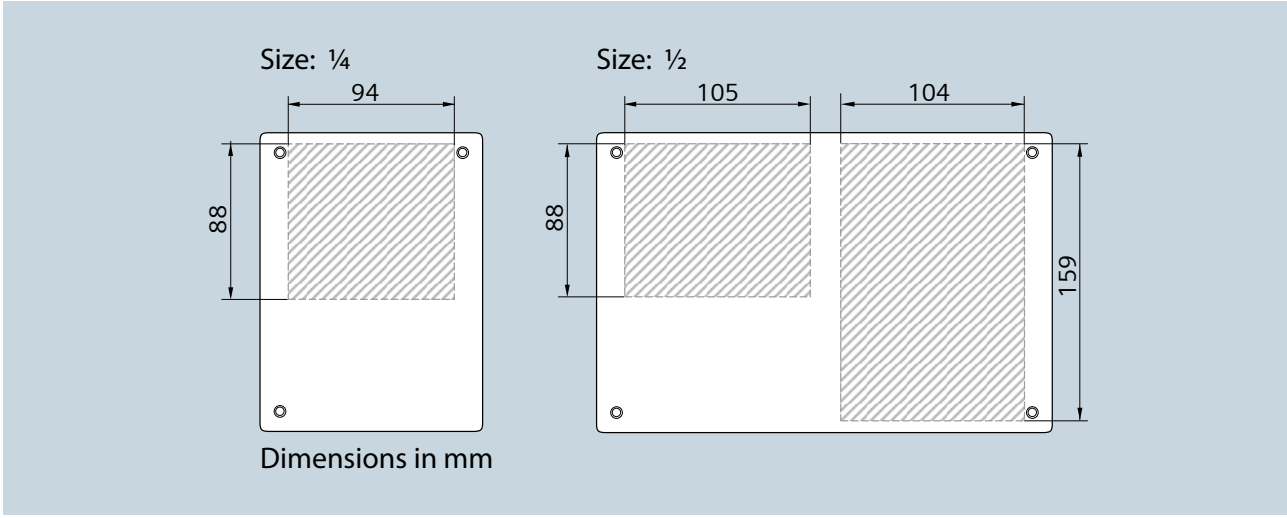

Fig. 4/12: Front areas usable for an instrument panel on small withdrawable units with an installation height of 200 mm

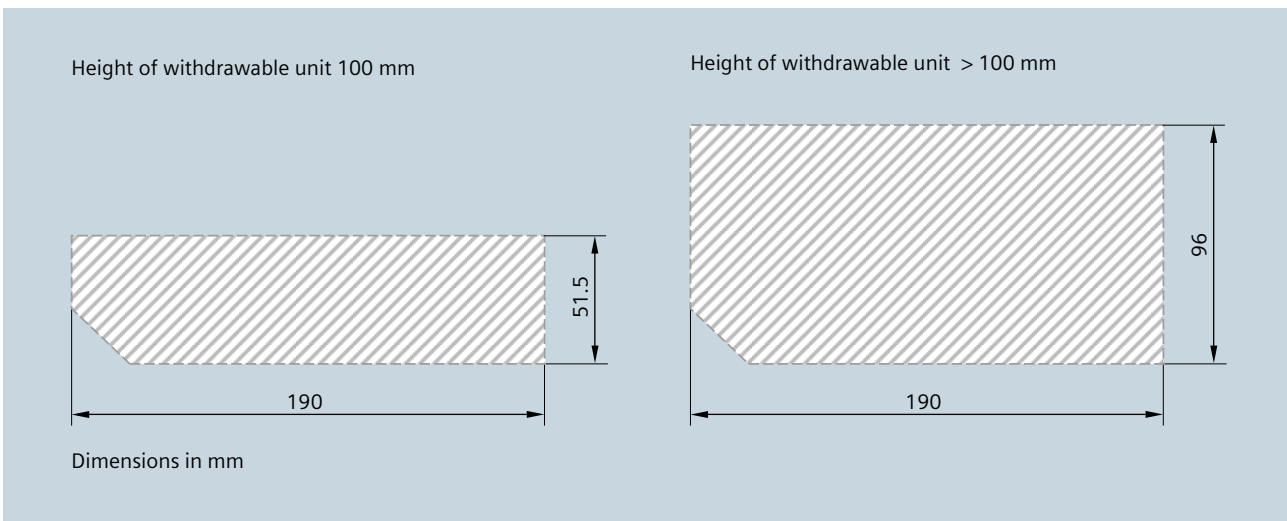

Fig. 4/13: Front areas usable for an instrument panel on normal withdrawable units

- 1
- 2
- 3
- 4
- 5
- 6
- 7
- 8
- 9
- 10
- 11

4.3.4 Withdrawable unit compartment in HFD

The vertical distribution busbar is covered test finger proofed (IP2X). Phase separation is possible. No connection work is required in the compartment (Fig. 4/14). The internal separation options up to form 4b lead to a high degree of personal safety.

For small withdrawable units, an adapter plate is mounted at the top of the compartment (Fig. 4/15). The tap-off openings for the input contacts of the withdrawable units in the compartment can be equipped with shutters. The

shutters are opened automatically when the withdrawable unit is inserted into the compartment.

Connection is effected in a separate cable connection compartment. The connection data for main circuits are stated in Tab. 4/14, those for auxiliary circuits in Tab. 4/15 and the number of available auxiliary contacts in Tab. 4/16.

The rated current for auxiliary contacts is:

- 6 A (250 V) for small withdrawable units
- 10 A (250 V) for normal withdrawable units



Fig. 4/14: Compartment for normal withdrawable unit in HFD



Fig. 4/15: Adapter plate for small withdrawable units

Tab. 4/14: Connection data for the main circuit

	Withdrawable unit height	Nominal feeder current	Terminal size	Maximum connection cross section
Small withdrawable unit	150 mm, 200 mm	≤ 35 A	16 mm ²	-
		≤ 63 A	35 mm ²	-
Normal withdrawable unit	100 mm	≤ 35 A	16 mm ²	-
		≤ 63 A	35 mm ²	-
	≥ 150 mm	≤ 250 A	-	1 x 185 mm ² 2 x 120 mm ²
		> 250 A	-	2 x 240 mm ² 4 x 120 mm ²

Tab. 4/15: Connection data for the auxiliary circuit

Type	Terminal size
Push-in terminal connection	2.5 mm ²
Screw connection	2.5 mm ²

Tab. 4/16: Number of available auxiliary contacts for withdrawable units in HFD

	Withdrawable unit height	Control plug type	Number of available auxiliary contacts		
			Without communication	With PROFIBUS	With PROFINET
Small withdrawable unit	150, 200 mm	26-pole	26	20	19
		40-pole	40	37	32
Normal withdrawable unit	≥ 100 mm	12-pole	12	9	12
		24-pole	24	21	24
	≥ 150 mm	32-pole	32	29	32
		40-pole	40	37	40

4.3.5 Ratings for cable feeders in SFD / HFD

Withdrawable units in SFD are applied up to a rated current of 250 A. The two withdrawable unit variants SFD and HFD can be mixed within one cubicle.

The thermal interaction of the feeders in the cubicle has to be and is considered by specifying the rated diversity factor (RDF):

Permissible continuous operational current (cable feeder) = rated current I_{nc} × RDF

For the feeders in the cubicle, the rated diversity factor RDF = 0.8 can be applied:

- regardless of the number of feeders in the cubicle
- regardless of the mounting position in the cubicle

Rated currents and minimum withdrawable unit heights for cable feeders are stated in Tab. 4/17. For cubicles with a very high packing and/or power density, a project-specific assessment is recommended. Further information is available from your Siemens contact.

Tab. 4/17: Rated currents and minimum withdrawable unit heights for cable feeders in SFD / HFD

Small withdrawable unit ¹⁾					
Type	Nominal device current	Minimum withdrawable unit size (height)		Rated current I_{nc} at 35 °C ambient temperature	
		3-pole	4-pole	Non-ventilated	Ventilated
Main switch and fuses ³⁾					
3LD22	32 A	150 mm - ¼, ½	150 mm - ¼, ½	32 A	32 A
3LD25	63 A	200 mm - ¼, ½	200 mm - ¼, ½	52.5 A	55.5 A
Circuit-breakers					
3RV2.1	16 A	150 mm - ¼, ½	-	14.6 A	15.2 A
3RV2.2	40 A	150 mm - ¼, ½	-	32 A	33.5 A
3RV2.3	52 A	150 mm - ½	-	40 A	41 A
3RV1.4	100 A	150 mm - ½	-	50 A	51.5 A
Normal withdrawable unit					
Type	Nominal device current	Minimum withdrawable unit size (height)		Rated current I_{nc} at 35 °C ambient temperature	
		3-pole	4-pole	Non-ventilated	Ventilated
Main switch and fuses ³⁾					
3LD22	32 A	100 mm	-	32 A	32 A
Switch-disconnectors with fuses ³⁾					
3KL50	63 A	150 mm	150 mm	63 A	63 A
3KL52	125 A	150 mm	150 mm	117 A	122 A
3KL53	160 A	200 mm	200 mm	137 A	142 A
3KL55	250 A	300 mm	300 mm	220 A	222 A
3KL57	400 A	300 mm	300 mm	305 A	340 A
3KL61	630 A	400 mm	500 mm	430 A	485 A
Circuit-breakers					
3RV2.1	16 A	100 mm	-	14.6 A	15.2 A
3RV2.2	40 A	100 mm	-	32 A	33.5 A
3RV2.3	52 A	150 mm	-	40 A	41 A
3RV1.4	100 A	150 mm	-	50 A	51.5 A
3VL1	160 A	200 mm	200 mm	135 A	141 A
3VL2	160 A	200 mm	200 mm	136 A	142 A
3VL3	250 A	200 mm	250 mm	201 A	217 A
3VL4	400 A	200 mm	400 mm	305 A	330 A
3VL5	630 A	300 mm	400 mm	375 A	415 A
3VL5	630 A	500 mm ²⁾	-	435 A	485 A
3VA10	100 A	150 mm	200 mm	92 A	97 A
3VA11	160 A	150 mm	200 mm	128 A	133 A
3VA12	250 A	200 mm	250 mm	218 A	226 A
3VA20	100 A	200 mm	200 mm	100 A	100 A
3VA21	160 A	200 mm	200 mm	155 A	160 A
3VA22	250 A	200 mm	250 mm	189 A	203 A
3VA23	400 A	300 mm	300 mm	320 A	350 A
3VA24	630 A	300 mm	400 mm	365 A	405 A

¹⁾ Type: ¼ = small withdrawable unit size ¼
½ = small withdrawable unit size ½

²⁾ Circuit-breaker in vertical mounting position

³⁾ Rated current with fuse link = nominal device current

4.3.6 Ratings for motor feeders in SFD / HFD

Withdrawable units in SFD are applied up to a rated current of 250 A. The two withdrawable unit variants SFD and HFD can be mixed within one cubicle.

The following tables list the minimum withdrawable unit sizes (Tab. 4/18 to Tab. 4/22) for motor feeders. Dependent on the number of project-specific secondary devices and the control wiring, larger withdrawable units might be required.

More detailed information about motor feeders is available from your local Siemens contact.

- Motor feeders for rated voltage 500 V and 690 V
- Motor feeders for tripping class up to CLASS 30
- Motor feeders for short-circuit breaking capacity up to 100 kA
- Motor feeders with soft starter
- Motor feeders with frequency converter
- Small withdrawable units for star-delta circuit

The thermal interaction of the feeders in the cubicle has to be and is considered by specifying the rated diversity factor (RDF):

Permissible continuous operational current (motor feeder) = rated current I_{nc} × RDF

For the feeders in the cubicle, the rated diversity factor RDF = 0.8 can be applied:

- regardless of the number of feeders in the cubicle
- regardless of the mounting position in the cubicle

For a rated diversity factor RDF > 0.8, the power grading next in size is to be set for the motor feeder.

For cubicles with a very high packing and/or power density, a project-specific assessment is recommended; information about that is available from your Siemens contact.

The standard values for the operating currents of three-phase asynchronous motors can be found in Chapter 10.

Tab. 4/18: Minimum withdrawable unit sizes for: fused motor feeders, 400 V, CLASS 10, with overload relay, type 2 at 50 kA

Small withdrawable unit ¹⁾				
Motor power P (AC-2/AC3)	Minimum withdrawable unit size at 35 °C ambient temperature			
	Height 150 mm		Height 200 mm	
	Direct contactor	Reversing circuit	Direct contactor	Reversing circuit
0.25 kW	¼, ½	¼, ½	¼, ½	¼, ½
0.37 kW	¼, ½	¼, ½	¼, ½	¼, ½
0.55 kW	¼, ½	¼, ½	¼, ½	¼, ½
0.75 kW	¼, ½	¼, ½	¼, ½	¼, ½
1.1 kW	¼, ½	¼, ½	¼, ½	¼, ½
1.5 kW	¼, ½	¼, ½	¼, ½	¼, ½
2.2 kW	¼, ½	¼, ½	¼, ½	¼, ½
3 kW	¼, ½	¼, ½	¼, ½	¼, ½
4 kW	¼, ½	¼, ½	¼, ½	¼, ½
5.5 kW	¼, ½	¼, ½	¼, ½	¼, ½
7.5 kW	¼, ½	¼, ½	¼, ½	¼, ½
11 kW	¼, ½	¼, ½	¼, ½	¼, ½
15 kW	½	½	¼, ½	½
18.5 kW	½	½	¼, ½	½

Normal withdrawable unit			
Motor power P (AC-2/AC3)	Minimum withdrawable unit height at 35 °C ambient temperature		
	Direct contactor	Reversing circuit	Star-delta
0.25 kW	100 mm	100 mm	150 mm
0.37 kW	100 mm	100 mm	150 mm
0.55 kW	100 mm	100 mm	150 mm
0.75 kW	100 mm	100 mm	150 mm
1.1 kW	100 mm	100 mm	150 mm
1.5 kW	100 mm	100 mm	150 mm
2.2 kW	100 mm	100 mm	150 mm
3 kW	100 mm	100 mm	150 mm
4 kW	100 mm	100 mm	150 mm
5.5 kW	100 mm	100 mm	150 mm
7.5 kW	100 mm	100 mm	150 mm
11 kW	100 mm	100 mm	150 mm
15 kW	150 mm	150 mm	150 mm
18.5 kW	150 mm	150 mm	200 mm
22 kW	150 mm	150 mm	200 mm
30 kW	200 mm	200 mm	200 mm
37 kW	200 mm	200 mm	200 mm
45 kW	200 mm	200 mm	250 mm
55 kW	400 mm	500 mm	250 mm
75 kW	400 mm	500 mm	250 mm
90 kW	400 mm	500 mm	500 mm
110 kW	500 mm	600 mm	500 mm
132 kW	500 mm	600 mm	500 mm
160 kW	500 mm	600 mm	500 mm
200 kW	600 mm	700 mm	700 mm
250 kW	600 mm	700 mm	700 mm

¹⁾ Type: ¼ = small withdrawable unit size ¼
½ = small withdrawable unit size ½

Tab. 4/19: Minimum withdrawable unit sizes for:
fused motor feeders, 400 V, CLASS 10,
with SIMOCODE, type 2 at 50 kA

Small withdrawable unit ¹⁾				
Motor power P (AC-2/AC3)	Minimum withdrawable unit size at 35 °C ambient temperature			
	Height 150 mm		Height 200 mm	
	Direct contactor	Reversing circuit	Direct contactor	Reversing circuit
0.25 kW	½	-	¼, ½	¼, ½
0.37 kW	½	-	¼, ½	¼, ½
0.55 kW	½	-	¼, ½	¼, ½
0.75 kW	½	-	¼, ½	¼, ½
1.1 kW	½	-	¼, ½	¼, ½
1.5 kW	½	-	¼, ½	¼, ½
2.2 kW	½	-	¼, ½	¼, ½
3 kW	½	-	¼, ½	¼, ½
4 kW	½	-	¼, ½	¼, ½
5.5 kW	½	-	¼, ½	¼, ½
7.5 kW	½	-	¼, ½	¼, ½
11 kW	½	-	¼, ½	¼, ½
15 kW	½	-	½	½
18.5 kW	½	-	½	½

Normal withdrawable unit			
Motor power P (AC-2/AC3)	Minimum withdrawable unit height at 35 °C ambient temperature		
	Direct contactor	Reversing circuit	Star-delta
0.25 kW	100 mm	100 mm	200 mm
0.37 kW	100 mm	100 mm	200 mm
0.55 kW	100 mm	100 mm	200 mm
0.75 kW	100 mm	100 mm	200 mm
1.1 kW	100 mm	100 mm	200 mm
1.5 kW	100 mm	100 mm	200 mm
2.2 kW	100 mm	100 mm	200 mm
3 kW	100 mm	100 mm	200 mm
4 kW	100 mm	100 mm	200 mm
5.5 kW	100 mm	150 mm	200 mm
7.5 kW	100 mm	150 mm	200 mm
11 kW	100 mm	150 mm	200 mm
15 kW	150 mm	150 mm	200 mm
18.5 kW	150 mm	150 mm	200 mm
22 kW	150 mm	150 mm	200 mm
30 kW	200 mm	200 mm	200 mm
37 kW	200 mm	200 mm	200 mm
45 kW	200 mm	200 mm	200 mm
55 kW	400 mm	500 mm	250 mm
75 kW	400 mm	500 mm	250 mm
90 kW	400 mm	500 mm	500 mm
110 kW	500 mm	600 mm	500 mm
132 kW	500 mm	600 mm	500 mm
160 kW	500 mm	600 mm	500 mm
200 kW	600 mm	700 mm	700 mm
250 kW	600 mm	700 mm	700 mm

¹⁾ Type: ¼ = small withdrawable unit size ¼
½ = small withdrawable unit size ½

Tab. 4/20: Minimum withdrawable unit sizes for:
fuseless motor feeders, 400 V, CLASS 10,
overload protection with circuit-breaker, type 2 at 50 kA

Small withdrawable unit ¹⁾				
Motor power P (AC-2/AC3)	Minimum withdrawable unit size at 35 °C ambient temperature			
	Height 150 mm		Height 200 mm	
	Direct contactor	Reversing circuit	Direct contactor	Reversing circuit
0.25 kW	¼, ½	¼, ½	¼, ½	¼, ½
0.37 kW	¼, ½	¼, ½	¼, ½	¼, ½
0.55 kW	¼, ½	¼, ½	¼, ½	¼, ½
0.75 kW	¼, ½	¼, ½	¼, ½	¼, ½
1.1 kW	¼, ½	¼, ½	¼, ½	¼, ½
1.5 kW	¼, ½	¼, ½	¼, ½	¼, ½
2.2 kW	¼, ½	¼, ½	¼, ½	¼, ½
3 kW	¼, ½	¼, ½	¼, ½	¼, ½
4 kW	¼, ½	¼, ½	¼, ½	¼, ½
5.5 kW	¼, ½	¼, ½	¼, ½	¼, ½
7.5 kW	¼, ½	¼, ½	¼, ½	¼, ½
11 kW	½	½	½	½
15 kW	½	½	½	½
18.5 kW	½	-	½	½
22 kW	½	-	½	½
30 kW	-	-	½	-

Normal withdrawable unit			
Motor power P (AC-2/AC3)	Minimum withdrawable unit height at 35 °C ambient temperature		
	Direct contactor	Reversing circuit	Star-delta
0.25 kW	100 mm	100 mm	150 mm
0.37 kW	100 mm	100 mm	150 mm
0.55 kW	100 mm	100 mm	150 mm
0.75 kW	100 mm	100 mm	150 mm
1.1 kW	100 mm	100 mm	150 mm
1.5 kW	100 mm	100 mm	150 mm
2.2 kW	100 mm	100 mm	150 mm
3 kW	100 mm	100 mm	150 mm
4 kW	100 mm	100 mm	150 mm
5.5 kW	100 mm	100 mm	150 mm
7.5 kW	100 mm	100 mm	150 mm
11 kW	100 mm	100 mm	150 mm
15 kW	100 mm	100 mm	150 mm
18.5 kW	150 mm	150 mm	200 mm
22 kW	150 mm	150 mm	200 mm
30 kW	150 mm	250 mm	250 mm
37 kW	150 mm	250 mm	250 mm
45 kW	150 mm	250 mm	250 mm
55 kW	300 mm	400 mm	400 mm
75 kW	300 mm	400 mm	400 mm
90 kW	300 mm	400 mm	400 mm
110 kW	400 mm	500 mm	500 mm
132 kW	500 mm	500 mm	700 mm
160 kW	500 mm	500 mm	700 mm
200 kW	700 mm	700 mm	700 mm
250 kW	700 mm	700 mm	700 mm

¹⁾ Type: ¼ = small withdrawable unit size ¼
½ = small withdrawable unit size ½

1
2
3
4
5
6
7
8
9
10
11

**Tab. 4/21: Minimum withdrawable unit sizes for:
fuseless motor feeders, 400 V, CLASS 10,
with overload relay, type 2 at 50 kA**

Small withdrawable unit ¹⁾				
Motor power P (AC-2/AC3)	Minimum withdrawable unit size at 35 °C ambient temperature			
	Height 150 mm		Height 200 mm	
	Direct contactor	Reversing circuit	Direct contactor	Reversing circuit
0.25 kW	¼, ½	¼, ½	¼, ½	¼, ½
0.37 kW	¼, ½	¼, ½	¼, ½	¼, ½
0.55 kW	¼, ½	¼, ½	¼, ½	¼, ½
0.75 kW	¼, ½	¼, ½	¼, ½	¼, ½
1.1 kW	¼, ½	¼, ½	¼, ½	¼, ½
1.5 kW	¼, ½	¼, ½	¼, ½	¼, ½
2.2 kW	¼, ½	¼, ½	¼, ½	¼, ½
3 kW	¼, ½	¼, ½	¼, ½	¼, ½
4 kW	¼, ½	¼, ½	¼, ½	¼, ½
5.5 kW	¼, ½	¼, ½	¼, ½	¼, ½
7.5 kW	¼, ½	¼, ½	¼, ½	¼, ½
11 kW	½	½	½	½
15 kW	½	½	½	½
18.5 kW	½	-	½	½
22 kW	½	-	½	½
30 kW	-	-	½	-

Normal withdrawable unit			
Motor power P (AC-2/AC3)	Minimum withdrawable unit height at 35 °C ambient temperature		
	Direct contactor	Reversing circuit	Star-delta
0.25 kW	100 mm	100 mm	150 mm
0.37 kW	100 mm	100 mm	150 mm
0.55 kW	100 mm	100 mm	150 mm
0.75 kW	100 mm	100 mm	150 mm
1.1 kW	100 mm	100 mm	150 mm
1.5 kW	100 mm	100 mm	150 mm
2.2 kW	100 mm	100 mm	150 mm
3 kW	100 mm	100 mm	150 mm
4 kW	100 mm	100 mm	150 mm
5.5 kW	100 mm	100 mm	150 mm
7.5 kW	100 mm	100 mm	150 mm
11 kW	100 mm	100 mm	150 mm
15 kW	100 mm	100 mm	150 mm
18.5 kW	150 mm	150 mm	200 mm
22 kW	150 mm	150 mm	200 mm
30 kW	150 mm	250 mm	250 mm
37 kW	150 mm	250 mm	250 mm
45 kW	150 mm	250 mm	250 mm
55 kW	300 mm	400 mm	400 mm
75 kW	300 mm	400 mm	400 mm
90 kW	300 mm	400 mm	400 mm
110 kW	400 mm	500 mm	500 mm
132 kW	500 mm	500 mm	700 mm
160 kW	500 mm	500 mm	700 mm
200 kW	700 mm	700 mm	700 mm
250 kW	700 mm	700 mm	700 mm

¹⁾ Type: ¼ = small withdrawable unit size ¼
½ = small withdrawable unit size ½

**Tab. 4/22: Minimum withdrawable unit sizes for:
fuseless motor feeders, 400 V, CLASS 10,
with SIMOCODE, type 2 at 50 kA**

Small withdrawable unit ¹⁾				
Motor power P (AC-2/AC3)	Minimum withdrawable unit size at 35 °C ambient temperature			
	Height 150 mm		Height 200 mm	
	Direct contactor	Reversing circuit	Direct contactor	Reversing circuit
0.25 kW	½	½	¼, ½	¼, ½
0.37 kW	½	½	¼, ½	¼, ½
0.55 kW	½	½	¼, ½	¼, ½
0.75 kW	½	½	¼, ½	¼, ½
1.1 kW	½	½	¼, ½	¼, ½
1.5 kW	½	½	¼, ½	¼, ½
2.2 kW	½	½	¼, ½	¼, ½
3 kW	½	½	¼, ½	¼, ½
4 kW	½	½	¼, ½	¼, ½
5.5 kW	½	½	¼, ½	¼, ½
7.5 kW	½	½	¼, ½	¼, ½
11 kW	½	½	½	½
15 kW	-	-	½	½
18.5 kW	-	-	½	-
22 kW	-	-	½	-
30 kW	-	-	½	-

Normal withdrawable unit			
Motor power P (AC-2/AC3)	Minimum withdrawable unit height at 35 °C ambient temperature		
	Direct contactor	Reversing circuit	Star-delta
0.25 kW	100 mm	100 mm	150 mm
0.37 kW	100 mm	100 mm	150 mm
0.55 kW	100 mm	100 mm	150 mm
0.75 kW	100 mm	100 mm	150 mm
1.1 kW	100 mm	100 mm	150 mm
1.5 kW	100 mm	100 mm	150 mm
2.2 kW	100 mm	100 mm	150 mm
3 kW	100 mm	100 mm	150 mm
4 kW	100 mm	100 mm	150 mm
5.5 kW	100 mm	100 mm	150 mm
7.5 kW	100 mm	100 mm	150 mm
11 kW	150 mm	150 mm	150 mm
15 kW	150 mm	150 mm	200 mm
18.5 kW	200 mm	250 mm	250 mm
22 kW	200 mm	250 mm	250 mm
30 kW	200 mm	250 mm	250 mm
37 kW	200 mm	250 mm	250 mm
45 kW	200 mm	250 mm	250 mm
55 kW	300 mm	400 mm	400 mm
75 kW	300 mm	400 mm	400 mm
90 kW	300 mm	400 mm	400 mm
110 kW	400 mm	500 mm	500 mm
132 kW	500 mm	500 mm	700 mm
160 kW	500 mm	500 mm	700 mm
200 kW	600 mm	700 mm	700 mm
250 kW	600 mm	700 mm	700 mm

¹⁾ Type: ¼ = small withdrawable unit size ¼
½ = small withdrawable unit size ½

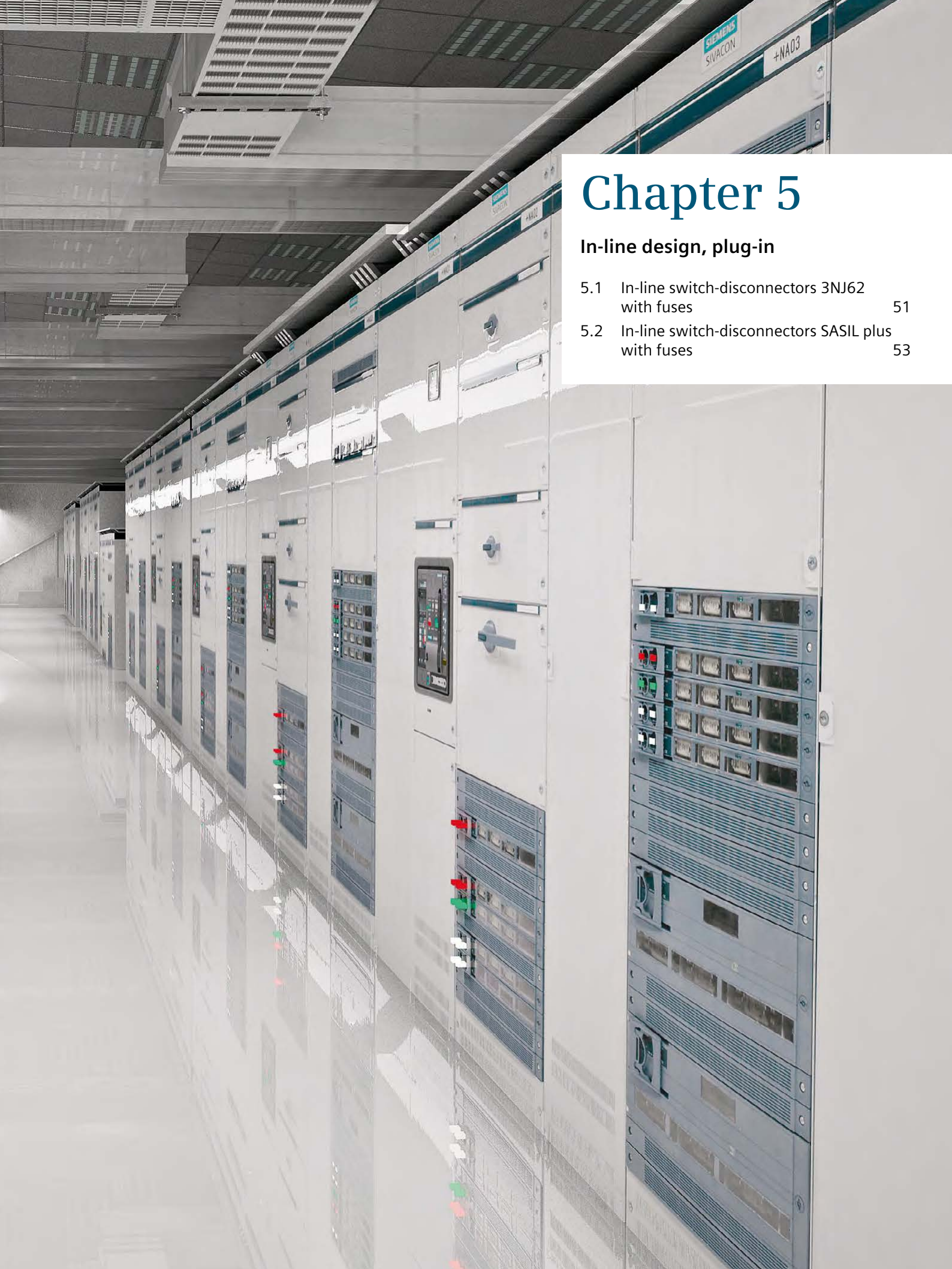

Chapter 5

In-line design, plug-in

- 5.1 In-line switch-disconnectors 3NJ62 with fuses 51
- 5.2 In-line switch-disconnectors SASIL plus with fuses 53

5 In-line design, plug-in

The plug-in design for SIVACON S8 switchboard (Fig. 5/1) with switching devices in in-line design with an incoming-side plug contact allows easy and fast modification or replacement under operating conditions. The pluggable in-line units are operated directly at the device. Tab. 5/1 gives an overview of the general cubicle characteristics.

Connection is effected directly at the switching device. The maximum cable cross sections that can be connected are stated in the device catalogues. The in-line switch-disconnector allows the installation of a measuring instrument for single-pole measurement. For three-pole measurement, the measuring instruments can be installed in the device or cable compartment door. The associated current transformers are integrated into the in-line unit on the cable feeder side.



Fig. 5/1: Cubicles for in-line design, plug-in: on the left for in-line switch-disconnectors 3NJ62 with fuses, on the right for switch-disconnectors SASIL plus with fuses

Tab. 5/1: General cubicle characteristics for in-line design, plug-in

Application range	- Incoming feeders up to 630 A - Outgoing cable feeders up to 630 A	
Degrees of protection	- Up to IP41	Ventilated
Cubicle dimensions	- Cubicle height - Cubicle width (front connection in the cubicle)	2,000, 2,200 mm 1,000, 1,200 mm
Device compartment	- Height - Width	1,550, 1,750 mm 600 mm
Form of internal separation	- Form 3b, 4b	
Design options	- In-line switch-disconnectors 3NJ62 with fuses - In-line switch-disconnectors SASIL plus with fuses (Jean Müller) - Empty slot, device compartment	

5.1 In-line switch-disconnectors 3NJ62 with fuses

In-line switch-disconnectors 3NJ62 with fuses (Fig. 5/2) provide single as well as double breaking as a standard feature.

Rating data of the vertical 3NJ62 distribution busbar

The vertical distribution busbars with the phase conductors L1, L2, L3 are arranged at the back of the cubicle. The PE, N or PEN busbars are arranged in the cable connection compartment. In the case of 4-pole feeders, the N conductor is allocated to the phase conductors L1, L2, L3 at the back of the cubicle.

The vertical distribution busbar is covered test finger proofed (IP2X). The rated data are stated in Tab. 5/2.

Rating data of the 3NJ62 cable feeders

Apart from the space requirements for additional built-in elements (Tab. 5/3), the derating factor stated in Tab. 5/4 is to be set for determining the permissible operating current of a fuse link. The space requirements for the cable feeders of the different in-line units depend on the nominal device current (Tab. 5/5).



Fig. 5/2: Pluggable in-line switch-disconnectors 3NJ62

Tab. 5/2: Rating data of the vertical distribution busbar 3NJ62

Distribution busbar cross section	60 x 10 mm ²	80 x 10 mm ²
Rated current at 35 °C ambient temperature	1,560 A	2,100 A
Rated short-time withstand current I_{cw} (1 sec) ¹⁾	50 kA	50 kA

¹⁾ Rated conditional short-circuit current $I_{cc} = 100$ kA

Tab. 5/3: Additional built-in elements for 3NJ62

Built-in elements	Height in mm	Version
Blanking cover for empty slots	50 ¹⁾	Plastic
	100, 200, 300	Metal
Device compartment (mounting plate with compartment door)	200, 400, 600	Usable overall device depth 180 mm

¹⁾ Accessory 3NJ6900-4CB00

Tab. 5/4: Derating factors for 3NJ62 fuse links

Nominal current of fuse link	Derating factor F
$I_n < 630$ A	0.8
$I_n \geq 630$ A	0.79

Tab. 5/5: Rating data of the 3NJ62 cable feeders

Type	Nominal device current	Space requirements of the in-line unit (height) ¹⁾		Size	Rated current ¹⁾ at 35 °C ambient temperature
		3-pole	4-pole		
3NJ6203	160 A	50 mm	100 mm	00	125 A
3NJ6213	250 A	100 mm	150 mm	1	200 A
3NJ6223	400 A	200 mm	250 mm	2	320 A
3NJ6233	630 A	200 mm	250 mm	3	500 A

¹⁾ Rated current with fuse link = nominal device current
The configuration rules stated in the following are to be observed

Configuration rules

For the completely equipped cubicle, the rated diversity factor (RDF) in accordance with IEC 61439-2 applies. Non-observance of these notes might result in premature ageing of fuses and their uncontrolled tripping due to local overheating. The permissible operating current of all in-line units in the cubicle is limited by the rated current of the vertical distribution busbar.

Rating data and arrangement notes for the configuration of in-line units and covers are given in Tab. 5/7. The in-line switch-disconnectors are arranged in the cubicle either in groups or individually in decreasing order from size 3 to size 00. Blanking covers with vent slots are mounted in between for ventilation.

All data refer to an ambient temperature of the switchgear of 35 °C on 24 h average. Conversion factors for different ambient temperatures are stated in Tab. 5/6.

Tab. 5/6: Conversion factors for different ambient temperatures

Ambient temperature of the switchgear	20 °C	25 °C	30 °C	35 °C	40 °C	45 °C	50 °C	55 °C
Conversion factor	1.10	1.07	1.04	1.00	0.95	0.90	0.85	0.80

Tab. 5/7: Configuration rules for 3NJ62: arrangement of the in-line units in the cubicle

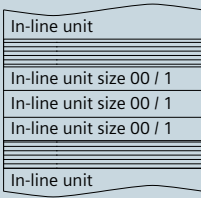
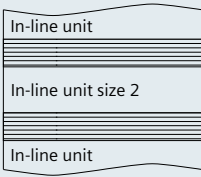
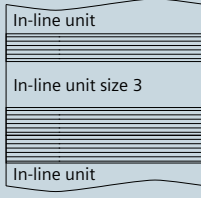
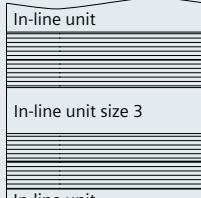
Size	Grouping	Blanking covers with vent slots	Example	Nominal current fuse:	Operating current:
00 1	Summation current of the group \leq 400 A	100 mm blanking cover below ¹⁾ the group		80 A 125 A 250 A Total:	64 A 100 A 200 A 364 A
2	Not permissible	50 mm blanking cover below ¹⁾ the in-line unit		400 A	320 A
3	Not permissible Operating current < 440 A	50 mm blanking cover above and 100 mm blanking cover below ¹⁾ the in-line unit		500 A	400 A
	Not permissible Operating current from 440 A to 500 A	100 mm blanking cover each above and below ¹⁾ the in-line unit		630 A	500 A

¹⁾ Below the bottommost in-line unit, only 50 mm blanking cover instead of 100 mm blanking cover or no blanking cover instead of 50 mm blanking cover required

5.2 In-line switch-disconnectors SASIL plus with fuses

Cubicles with pluggable in-line switch-disconnectors can also be equipped with SASIL plus in-line units (Fig. 5/3) produced by Jean Müller.

Rating data of the vertical distribution busbar SASIL plus

The vertical distribution busbars with the phase conductors L1, L2, L3 are arranged at the back of the cubicle. The PE, N or PEN busbars are arranged in the cable connection compartment. In the case of 4-pole feeders, the N conductor is allocated to the phase conductors L1, L2, L3 at the back of the cubicle. The vertical distribution busbar is covered test finger proofed (IP2X). The rated data are stated in Tab. 5/8.

Rating data of the SASIL plus cable feeders

Apart from the space requirements for additional built-in elements (Tab. 5/9), the derating factor stated in Tab. 5/10 is to be set for determining the permissible operating current of a fuse link. The space requirements for the cable feeders of the different in-line units depend on the nominal device current (Tab. 5/11).



Fig. 5/3: Pluggable in-line switch-disconnectors SASIL plus

Tab. 5/8: Rating data of the vertical distribution busbar SASIL plus

Distribution busbar cross section	60 x 10 mm ²	80 x 10 mm ²
Rated current at 35 °C ambient temperature	1,560 A	2,100 A
Rated short-time withstand current I_{cw} (1 sec) ¹⁾	50 kA	50 kA

¹⁾ Rated conditional short-circuit current $I_{cc} = 100$ kA

Tab. 5/9: Additional built-in elements for SASIL plus

Built-in elements	Height in mm	Version
Blanking cover for empty slots	50, 75, 150, 300	Metal
Device compartment (mounting plate with compartment door)	150, 200, 300, 450, 600	Without power tapping, usable overall device depth 180 mm
	200, 300, 450, 600	With power tapping, usable overall device depth 180 mm

Tab. 5/10: Derating factors for SASIL plus fuse links

Nominal current of fuse link	Derating factor F
$I_n \leq 32$ A	1
32 A < $I_n \leq 160$ A	0.76
160 A < $I_n \leq 630$ A	0.81

Tab. 5/11: Rating data of the SASIL plus cable feeders

Size	Nominal device current	Space requirements of the in-line unit (height) ¹⁾		Rated current ¹⁾ at 35 °C ambient temperature
		3-pole	4-pole	
00	160 A	50 mm	100 mm	122 A
1	250 A	75 mm	150 mm	203 A
2	400 A	150 mm	300 mm	324 A
3	630 A	150 mm	300 mm	510 A

¹⁾ Rated current with fuse link = nominal device current
The configuration rules stated in the following are to be observed

Configuration rules

For the completely equipped cubicle, the RDF in accordance with IEC 61439-2 applies. Non-observance of these notes might result in premature ageing of fuses and their uncontrolled tripping due to local overheating. The permissible operating current of all in-line units in the cubicle is limited by the rated current of the vertical distribution busbar.

All data refer to an ambient temperature of the switchgear of 35 °C on 24 h average. Conversion factors for different ambient temperatures are stated in Tab. 5/12.

Rating data and arrangement notes for the configuration of in-line units and covers are given in Tab. 5/13. The in-line switch-disconnectors are arranged in the cubicle either in groups or individually in decreasing order from size 3 to size 00. Blanking covers with vent slots are mounted in between for ventilation.

Tab. 5/12: Conversion factors for different ambient temperatures

Ambient temperature of the switchgear	20 °C	25 °C	30 °C	35 °C	40 °C	45 °C	50 °C	55 °C
Conversion factor	1.10	1.07	1.04	1.00	0.96	0.93	0.89	0.85

Tab. 5/13: Configuration rules for SASIL plus: arrangement of the in-line units in the cubicle

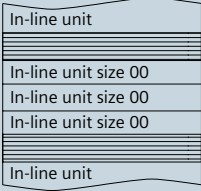
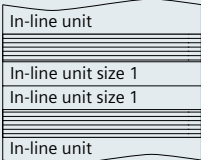
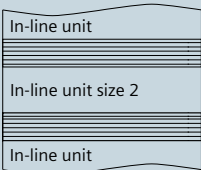
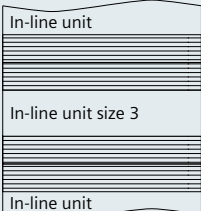
Size	Grouping	Blanking covers 75 mm with vent slots	Example	Nominal current fuse:	Operating current:
00	Summation current of the group ≤ 319 A	One blanking cover each above and below ¹⁾ the group		80 A 100 A 160 A Total:	60 A 76 A 122 A 256 A
1	Summation current of the group ≤ 365 A	One blanking cover each above and below ¹⁾ the group		250 A 250 A Total:	182 A 182 A 364 A
2	Not permissible	One blanking cover each above and below ¹⁾ the group		355 A	288 A
3	Not permissible	Two blanking covers each above and below ¹⁾ the group		630 A	510 A

¹⁾ Below the bottommost in-line unit, only 75 mm blanking cover instead of 150 mm blanking cover or no blanking cover instead of 75 mm blanking cover required

Chapter 6

Cubicles in fixed-mounted design

6.1	In-line design, fixed-mounted	56
6.2	Fixed-mounted design with front cover	59
6.3	Cubicle for customized solutions	63

A photograph of a Siemens SIVACON cubicle. The cubicle is light grey with a vertical ribbed frame. A white label with a green border is mounted at the top left, displaying the 'SIEMENS' logo in white on a green background and 'SIVACON' in black below it. The cubicle door is partially open, revealing a black handle and a lock mechanism. The background shows a dark teal ceiling with recessed lighting.

SIEMENS
SIVACON

6 Cubicles in fixed-mounted design

If the exchange of components under operating conditions is not required or if short downtimes are acceptable, then the fixed-mounted design offers a safe and cost-efficient solution.

6.1 In-line design, fixed-mounted

The cubicles for cable feeders in fixed-mounted design up to 630 A are equipped with vertically installed fuse switch-disconnectors 3NJ4 (Fig. 6/1). The cubicles are available with rear busbar position. Due to their compact and modular design, they allow optimal cost-efficient applications in the infrastructure sector. Design-verified standard modules guarantee maximum safety.

Dependent on the cubicle width, multiple switch-disconnectors of size 00 to 3 can be installed. For the installation of additional auxiliary devices, standard rails, wiring ducts, terminal blocks etc., a device support plate can be provided in the cubicle. Alternatively, it is possible to install an ALPHA small distribution board. Measuring instruments and control elements are installed in the door.



Fig. 6/1: Cubicles for fixed-mounted in-line design with 3NJ4 in-line switch-disconnectors

General cubicle characteristics

Tab. 6/1 summarizes the general cubicle characteristics. The switch-disconnectors are fixed-mounted on the horizontal busbar system. Cable connection is effected directly on the device front. The maximum cable cross sections that can be connected are stated in the device catalogue. The cables can be led into the cubicle from top or bottom.

The switch-disconnectors can be equipped with up to three current transformers to enable feeder-related measurements. In order to implement cubicle-related summation current measurements, the system provides the option to install current transformers in the busbar system.

Tab. 6/1: General cubicle characteristics for fixed-mounted in-line design

Application range	- Incoming feeders up to 630 A - Outgoing cable feeders up to 630 A	
Degrees of protection	- Up to IP31 - Up to IP43 - IP54	Ventilated, door with cut-out Ventilated Non-ventilated
Cubicle dimensions	- Cubicle height - Cubicle width (front connection in the cubicle)	2,000, 2,200 mm 600, 800, 1,000 mm
Device compartment	- If cubicle width 600 mm - If cubicle width 800 mm - If cubicle width 1,000 mm	Device compartment width 500 mm Device compartment width 700 mm Device compartment width 900 mm
Form of internal separation	- Form 1b, 2b	Door, cubicle high
Design options	- In-line fuse switch-disconnectors 3NJ4 (3-pole) - With or without current measurement - Empty slot cover	

Rating data of the cable feeders

Tab. 6/2 states the space requirements and the respective rated current dependent on the in-line unit type.

Tab. 6/2: Rating data of the 3NJ4 cable feeders

Type	Nominal device current	Space requirements of the in-line unit	Rated current ¹⁾ at 35 °C ambient temperature	
			Non-ventilated	Ventilated
3NJ410	160 A	50 mm	117 A	136 A
3NJ412	250 A	100 mm	200 A	220 A
3NJ413	400 A	100 mm	290 A	340 A
3NJ414	630 A	100 mm	380 A	460 A

¹⁾ Rated current with fuse link = nominal device current

Additional built-in elements

If the busbar and cable connection positions in the cubicle are identical, one of three possible additional built-in elements (see Tab. 6/3) can be used. The possible arrangements are listed in Tab. 6/4.

Tab. 6/3: Dimensions if additional built-in elements are used

Device holder	Installation depth	370 mm
	Installation height	625 mm (cubicle height 2,000 mm) 725 mm (cubicle height 2,200 mm)
ALPHA 8GK rapid mounting kit for series-mounted devices	Height	450 mm (3 rows)
2 nd row in-line unit size 00	Data stated in Tab. 6/5 or Tab. 6/6	

Tab. 6/4: Mounting location of additional built-in elements

Busbar position	Cable connection	Additional built-in element installed in the cubicle
Bottom	Bottom	Top
Top	Top	Bottom
Bottom	Top	Not possible
Top	Bottom	Not possible

Additional built-in elements for in-line units of size 00 in 2nd row

Mounting additional built-in elements for 3NJ4 in-line units of size 00 is possible for cubicles up to degree of protection IP31 and operation of the main in-line switch-disconnectors through the door (door with cutout).

The additional in-line switch-disconnectors are operated behind the door. This arrangement results in a smaller width of the device compartment (Tab. 6/5). The rated data of the cable feeders are stated in Tab. 6/6. The connection is established directly at the switching device from top or bottom. Due to the restricted connection compartment, connections with cable cross sections up to 95 mm² are possible.

Tab. 6/5: Device compartment for in-line units in the 2nd row

Cubicle width	Width of device compartment
600 mm	300 mm
800 mm	500 mm
1,000 mm	700 mm

Tab. 6/6: Rating data of the cable feeders for in-line units in the 2nd row

Type	Nominal device current	Space requirements in-line unit	Max. number of in-line units per cubicle	Rated current ¹⁾ at 35 °C ambient temperature
Installation at the top in the cubicle				
3NJ410	160 A	50 mm	10	95 A
			14	74 A
Installation at the bottom in the cubicle				
3NJ410	160 A	50 mm	10	107 A
			14	92 A
¹⁾ Rated current with fuse link = nominal device current				

Equipment rules for 3NJ4 in-line fuse switch-disconnectors

Arrangement options for the in-line units in the cubicle:

- From left to right with in-line units decreasing in size
- From right to left with in-line units decreasing in size

The specified rated currents are applicable when the 3NJ4 in-line units are equipped with the largest possible fuse links. When using smaller links, a corresponding utilization (in percent) is permissible.

Example:

- 3NJ414 in-line unit in a non-ventilated cubicle (Tab. 6/2: 380 A)
- Equipped with 500 A link

Max. permissible continuous operational current =
= (380 A / 630 A) x 500 A = 300 A

6.2 Fixed-mounted design with front cover

The front covers, which are easy to install, allow for the implementation of cubicles with uniform front surfaces (Fig. 6/2). Optionally a glass door can be used. The profile bar design or flat copper design of the distribution busbar allows tapping in the smallest grids. Furthermore, connections to the distribution busbars by means of cables, wires or busbars are possible without any need of drilling or punching. This ensures maximum flexibility also for later expansions.

General cubicle characteristics

Tab. 6/7 summarizes the general cubicle characteristics. The switching devices are installed on modular device holders of graduated depth. These can be equipped with circuit-breakers, switch-disconnectors with fuses or modular installation devices. Different switching device groupings into one module are also possible. Modules are attached to the device holder and directly connected to the cubicle busbar.

To the front, the devices are equipped with front covers. Operation is effected through the cover. The cable connection is effected at the device or, in cases of higher requirements, at special connection terminals. For individual expansion, the system offers freely assignable device holders.



Fig. 6/2: Cubicles for fixed mounting with front cover

Tab. 6/7: General cubicle characteristics for fixed-mounted cubicles with front cover

Application range	<ul style="list-style-type: none"> - Incoming feeders up to 630 A - Outgoing cable feeders up to 630 A - Modular installation devices 	
Degrees of protection	<ul style="list-style-type: none"> - Up to IP43 - IP54 	<ul style="list-style-type: none"> Ventilated Non-ventilated
Cubicle dimensions	<ul style="list-style-type: none"> - Cubicle height - Cubicle width (front connection in the cubicle) 	<ul style="list-style-type: none"> 2,000, 2,200 mm 1,000, 1,200 mm
Device compartment	<ul style="list-style-type: none"> - Height - Width 	<ul style="list-style-type: none"> 1,600, 1,800 mm 600 mm
Form of internal separation	<ul style="list-style-type: none"> - Form 1, 2b, 3b, 4a, 4b 	<ul style="list-style-type: none"> Door, viewing door cubicle high ¹⁾
Design options	<ul style="list-style-type: none"> - Fixed-mounted module with front cover - Mounting kit for modular installation devices - Empty slot, device compartment 	

¹⁾ Cubicle with degree of protection less than or equal to IP31 is also possible without an additional cubicle high door

Vertical distribution busbar

The vertical distribution busbars with the phase conductors L1, L2, L3 are arranged at the left in the cubicle. The PE, N or PEN busbars are arranged in the cable connection compartment.

In the case of 4-pole feeders, the N conductor is allocated to the phase conductors L1, L2, L3 at the back of the cubicle. Ratings are stated in Tab. 6/8.

Tab. 6/8: Rating data of the vertical distribution busbar

Distribution busbar		Profile bar		Flat copper ¹⁾	
Cross section		400 mm ²	650 mm ²	1 x (40 mm x 10 mm)	2 x (40 mm x 10 mm)
Rated current at 35 °C ambient temperature	Ventilated	905 A	1,100 A	865 A	1,120 A
	Non-ventilated	830 A	1,000 A	820 A	1,000 A
Rated short-time withstand current I_{cw} (1 sec) ²⁾		65 kA	65 kA	65 kA	65 kA

¹⁾ Top main busbar position
²⁾ Rated conditional short-circuit current $I_{cc} = 150$ kA

Mounting

One or multiple switching device(s) is/are mounted on device holders of graduated depth and connected to the vertical distribution busbars with the incoming feeder side

(Fig. 6/3). To the front, the devices are equipped with front covers. Operation is effected through the cover.

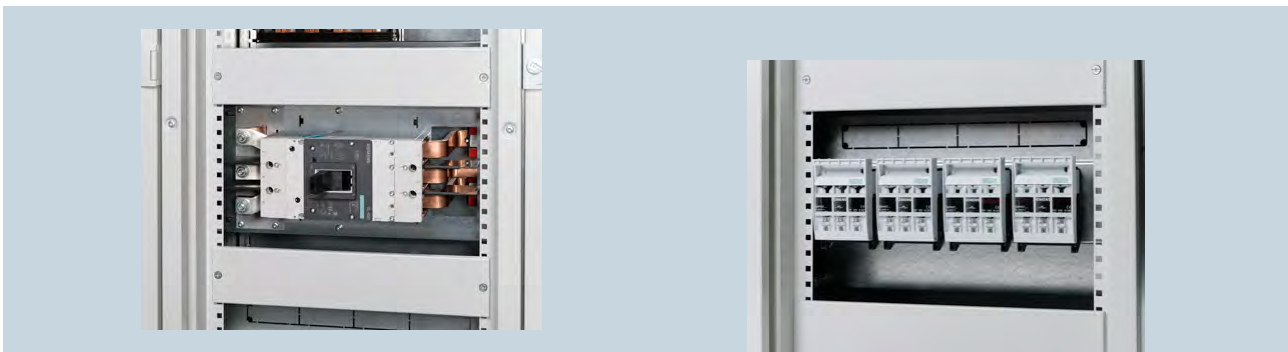

Fig. 6/3: Installation of switching devices in fixed-mounted cubicles with a front cover (cover opened)

Cable connection

For form 1, 2b and 4a, the cable connection is effected directly at the switching device. The maximum cross sections that can be connected are stated in the device catalogues.

For form 4b, the cable connection is effected in the cable connection compartment. Tab. 6/9 states the maximum conductor cross sections and Fig. 6/4 shows a detail with connections.

Tab. 6/9: Conductor cross sections in fixed-mounted cubicles with a front door

Nominal feeder current	Max. conductor cross section
≤ 250 A	120 mm ²
> 250 A	240 mm ²

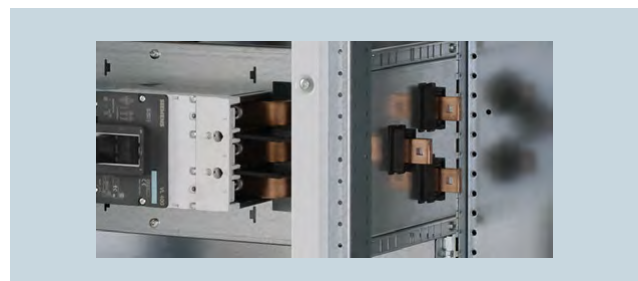

Fig. 6/4: Cable connections in fixed-mounted cubicles with a front cover

Rating data of the cable feeders

Tab. 6/10 and Tab. 6/11 states the installation data of the switching devices if used in fixed-mounted cubicles with a front door. The thermal interaction of the outgoing feeders in the cubicle has to be and is considered by specifying the rated diversity factor (RDF):

Permissible continuous operational current (cable feeder) =
= rated current I_{nc} x RDF

For the outgoing feeders in the cubicle, the rated diversity factor RDF = 0.8 can be applied:

- regardless of the number of feeders in the cubicle
- regardless of the mounting position in the cubicle

For cubicles with a very high packing and/or power density, a project-specific assessment is recommended. More detailed information is available via your Siemens contact.

Tab. 6/10: Rating data of the cable feeders for fuse-switch-disconnectors and switch-disconnectors with fuses

Type	Nominal device current	Number per row	Module height		Rated current I_{nc} at 35 °C ambient temperature	
			3-pole / 4-pole	3-pole	4-pole	Non-ventilated
Fuse switch-disconnectors ¹⁾						
3NP1123	160 A	1	150 mm	-	106 A	120 A
3NP1123	160 A	4	300 mm	-	106 A	120 A
3NP1133	160 A	1	200 mm	-	123 A	133 A
3NP1133	160 A	3	300 mm	-	123 A	133 A
3NP1143	250 A	1	250 mm	-	222 A	241 A
3NP1153	400 A	1	300 mm	-	350 A	375 A
3NP1163	630 A	1	300 mm	-	480 A	530 A
3NP4010	160 A	1	150 mm	-	84 A	96 A
3NP4010	160 A	4	300 mm	-	84 A	96 A
3NP4070	160 A	1	200 mm	-	130 A	142 A
3NP4070	160 A	3	300 mm	-	130 A	142 A
3NP4270	250 A	1	250 mm	-	248 A	250 A
3NP4370	400 A	1	300 mm	-	355 A	370 A
3NP4470	630 A	1	300 mm	-	480 A	515 A
3NP5060	160 A	1	200 mm	-	84 A	96 A
3NP5060	160 A	3	350 mm	-	84 A	96 A
3NP5260	250 A	1	250 mm	-	248 A	250 A
3NP5360	400 A	1	300 mm	-	355 A	370 A
3NP5460	630 A	1	300 mm	-	480 A	515 A
Switch-disconnectors with fuses ¹⁾						
3KL50	63 A	1	250 mm	250 mm	61 A	63 A
3KL52	125 A	1	250 mm	250 mm	120 A	125 A
3KL53	160 A	1	250 mm	250 mm	136 A	143 A
3KL55	250 A	1	350 mm	350 mm	250 A	250 A
3KL57	400 A	1	350 mm	350 mm	345 A	355 A
3KL61	630 A	1	550 mm	550 mm	535 A	555 A

¹⁾ Rated current with fuse link = nominal device current

Tab. 6/11: Rating data of the cable feeders for circuit-breakers

Type	Nominal device current	Number per row	Module height		Rated current I_{nc} at 35 °C ambient temperature	
			3-pole / 4-pole	3-pole	4-pole	Non-ventilated
Circuit-breakers						
3RV2.1	16 A	1	16 mm	-	12.7 A	14.1 A
3RV2.1	16 A	9	16 mm	-	12.7 A	14.1 A
3RV2.2	40 A	1	40 mm	-	27 A	31.5 A
3RV2.2	40 A	9	40 mm	-	27 A	31.5 A
3RV2.3	52 A	1	150 mm	-	39 A	40.5 A
3RV2.3	52 A	7	250 mm	-	39 A	40.5 A
3RV1.4	100 A	1	150 mm	-	71 A	79 A
3RV1.4	100 A	6	300 mm	-	71 A	79 A
3VL1	160 A	1	150 mm	200 mm	121 A	151 A
3VL1	160 A	4 / 3	350 mm	450 mm	121 A	151 A
3VL2	160 A	1	150 mm	200 mm	130 A	158 A
3VL2	160 A	4 / 3	350 mm	450 mm	130 A	158 A
3VL3	250 A	1	200 mm	250 mm	248 A	250 A
3VL4	400 A	1	250 mm	300 mm	400 A	400 A
3VL5	630 A	1	300 mm	350 mm	525 A	565 A
3VA10	100 A	1	150 mm	150 mm	72 A	85 A
3VA10	100 A	5 / 4	400 mm	400 mm	72 A	85 A
3VA11	160 A	1	150 mm	150 mm	112 A	125 A
3VA11	160 A	5 / 4	400 mm	400 mm	112 A	125 A
3VA12	250 A	1	200 mm	250 mm	232 A	246 A
3VA20	100 A	1	150 mm	200 mm	100 A	100 A
3VA20	100 A	4 / 3	350 mm	350 mm	83 A	100 A
3VA21	160 A	1	150 mm	200 mm	160 A	160 A
3VA21	160 A	4 / 3	350 mm	350 mm	90 A	125 A
3VA22	250 A	1	200 mm	250 mm	201 A	226 A
3VA23	400 A	1	250 mm	300 mm	350 A	400 A
3VA24	630 A	1	250 mm	300 mm	410 A	495 A

Device compartments

The device compartment consists of a fixed device holder with a uniform usable overall depth of 310 mm. The device compartment is closed with a front cover. The five typical module heights are: 200, 300, 400, 500 and 600 mm.

Mounting kits for modular installation devices

Thanks to the different mounting kits, one or more row(s) of modular installation devices can be installed in the switchboard. Tab. 6/12 states the configurations dependent on the module height. The mounting kit (Fig. 6/5) comprises the 35 mm multi-profile rails for the mounting of modular installation devices of size 1, 2 or 3 in accordance with DIN 43880 and a front cover. The multi-profile rail allows the SIKclip 5ST25 wiring system to be snapped on at the back.

Tab. 6/12: Configuration data of the mounting kits for modular installation devices

Installation width	Number of rows	Distance between rows	Module height
24 HP ¹⁾	1	150 mm	150 mm
		200 mm	200 mm
	2	150 mm	300 mm
		200 mm	400 mm
	3	150 mm	450 mm
		200 mm	600 mm

¹⁾ HP = horizontal pitch = 18 mm



Fig. 6/5: Mounting kit for modular installation devices (without cover)

6.3 Cubicle for customized solutions

For individual configuration and flexible expansion of cubicles, additional cubicles for customized solutions are

available for SIVACON S8 switchgear (Fig. 6/6). Their general characteristics are stated in Tab. 6/13 and the configuration data are described in Tab. 6/14.



Fig. 6/6: Cubicles for customized solutions

Tab. 6/13: General characteristics for cubicles for customized solutions

Application range	- Fixed-mounted cubicle with mounting plate for individual configuration - Use as cubicle expansion ¹⁾	
Degrees of protection	- Up to IP43 - IP54	Ventilated Non-ventilated
Cubicle dimensions	- Cubicle height - Cubicle width (front connection in the cubicle)	2,000, 2,200 mm see Tab. 6/14 (cubicle design)
Device compartment	- Height - Width	1,600, 1,800 mm see Tab. 6/14 (cubicle design)
Form of internal separation	- Form 1, 2b	Door, viewing door cubicle high
Design options	- Mounting plate - ALPHA 8GK rapid mounting kits ²⁾ - With / without main busbar - With / without vertical distribution busbar	

¹⁾ Expansion of cubicles to the left or right

²⁾ Cubicle height 2,000 mm, rear main busbar position

Cubicle design

Tab. 6/14: Configuration data on cubicle design for customized solutions

Cubicle width	Width of device compartment	Cable connection compartment	Vertical distribution busbar
1,000 mm ¹⁾ (600 mm +400 mm), 1,200 mm ¹⁾ (600 mm + 600 mm)	600 mm	Right	Yes / No
200 mm ²⁾ , 350 mm ³⁾ , 400 mm, 600 mm, 800 mm, 850 mm ³⁾ , 1,000 mm	Corresponding to the cubicle width	Without	No
600 mm ⁴⁾	600 mm	Rear	Yes / No

¹⁾ Front connection in the cubicle
²⁾ Width 200 mm as cubicle expansion
³⁾ Cubicle height 2,000 mm, single-front systems
⁴⁾ Rear connection in the cubicle

Vertical distribution busbar

The vertical distribution busbars with the phase conductors L1, L2, L3 are arranged at the left in the cubicle. The PE, N or PEN busbars are arranged in the cable connection com-

partment. In the case of 4-pole feeders, the N conductor is allocated to the phase conductors L1, L2, L3 at the back of the cubicle. Ratings are stated in Tab. 6/15.

Tab. 6/15: Rating data of the vertical distribution busbar

Distribution busbar		Profile bar		Flat copper ¹⁾	
Cross section		400 mm ²	650 mm ²	1 x (40 mm x 10 mm)	2 x (40 mm x 10 mm)
Rated current at 35 °C ambient temperature	Ventilated	905 A	1,100 A	865 A	1,120 A
	Non-ventilated	830 A	1,000 A	820 A	1,000 A
Rated short-time withstand current I_{cw} (1 sec) ²⁾		65 kA	65 kA	65 kA	65 kA

¹⁾ Top main busbar position
²⁾ Rated conditional short-circuit current $I_{cc} = 150$ kA

Mounting options

The dimensions and arrangement options for mounting plates and ALPHA 8GK rapid mounting kits are stated in Tab. 6/16.

More detailed information on the ALPHA 8GK rapid mounting kits is available in the relevant product catalogues.

Tab. 6/16: Configuration data on mounting options for customized solutions

Mounting plates			
Cubicle height	Main busbar	Overall height of mounting plate	Version
2,000 mm	No	1,600 mm	- Separated / unseparated - Perforated / non-perforated
	Yes	1,800 mm	
2,200 mm	No	2,000 mm	
	Yes	1,800 mm	
ALPHA 8GK rapid mounting kits			
Cubicle height	Main busbar	Compartment	
		Height	Width
2,000 mm	Without	1,800 mm	350 ¹⁾ , 600, 800 mm
	Rear position	1,650 mm	

¹⁾ No viewing door



Chapter 7

Reactive power compensation

7.1	Configuration and calculation	68
7.2	Separately installed compensation cubicles	70

7 Reactive power compensation

The cubicles for reactive power compensation (Fig. 7/1) relieve transformers and cables, reduce transmission losses and thus save energy. Dependent on the consumer structure, reactive power compensation is equipped with non-choked or choked capacitor modules. The controller

module for electronic reactive power compensation can be installed in the door. Tab. 7/1 summarizes the general cubicle characteristics.



Fig. 7/1: Cubicle for reactive power compensation

Tab. 7/1: General characteristics of cubicles for reactive power compensation

Application range	- Controlled reactive power compensation	
Degrees of protection	- Up to IP43	Ventilated
Cubicle dimensions	- Cubicle height - Width	2,000, 2,200 mm 800 mm
Device compartment	- Height - Width	1,600, 1,800 mm 600 mm
Form of internal separation	- Form 1, 2b	Door, cubicle high
Design options	<ul style="list-style-type: none"> - Non-choked - Choked 5.67 %, 7 %, 14 % - With / without main busbar - With connection to main busbar or with external connection - With / without line-side switch-disconnector module as cut-off point between main busbars and vertical distribution bar 	

Compensation modules

Dependent on the consumer type, non-choked and choked capacitor modules are used for reactive power compensation. A module with fuse switch-disconnectors can optionally be installed to disconnect the capacitor modules (Fig. 7/2) from the main busbar.

- **Non-choked capacitor modules**
Non-choked modules are mainly used for central compensation of reactive power with mainly linear consumers. They are divided into several, separately switchable capacitor modules. The reactive power controller installed in the door enables adhering to the specified set $\cos \varphi$ even under varying load conditions.
- **Choked capacitor modules**
Choked modules have an additional inductance. They are used for compensating reactive power in networks with non-linear loads (15 - 20 % of the total load) and a high harmonic component. In addition to capacitive reactive power, choked modules also provide filtering of low-frequency harmonics.

Audio frequency ripple control systems and compensation

Ripple control signals can be used in the power supply network to control power consumers remotely. The signals for audio frequency ripple control systems (AF) are in the range of 110 and 2,000 Hz. The dependency of the choking level from the audio frequency suppressor is listed in Tab. 7/2.

Using an audio frequency suppressor is required to prevent suppressing ripple control signals from the network. The audio frequency suppressor depends on the frequency of the ripple control signal of the respective network operator and must be adjusted if required. Special variants are available on request.



Fig. 7/2: Capacitor modules for reactive power compensation

Tab. 7/2: Choked capacitor modules with built-in audio frequency suppressor

Choking rate	Audio frequency suppressor
5.67 %	> 350 Hz
7 %	> 250 Hz
14 %	> 160 Hz

1

2

3

4

5

6

7

8

9

10

11

7.1 Configuration and calculation

When cubicles with direct connection to the main busbar are configured, the selection of capacitor modules depends

on the total power in this cubicle and the number of modules, as it becomes apparent in Tab. 7/3.

Tab. 7/3: Configuration of capacitor modules

Cubicle height	Compensation power per cubicle	Number of modules	Type			
			Non-choked		Choked 5.67 %, 7 %, 14 % ¹⁾	
			Without switch-disconnector	With switch-disconnector	Rear busbar position	Top busbar position
Reactive power per cubicle: 600 kvar / 400 V / 50 Hz at 35 °C ambient temperature						
2,200 mm	600 kvar	12 x 50 kvar	+	-	-	-
Cubicle power: up to 500 kvar / 400 V, 525 V, 690 V / 50 Hz at 35 °C ambient temperature						
2,000 mm, 2,200 mm	50 kvar	2 x 25 kvar	+	+	+	+
	100 kvar	4 x 25 kvar	+	+	+	+
	150 kvar	6 x 25 kvar	+	+	+	+
	200 kvar	4 x 50 kvar	+	+	+	+
	250 kvar	5 x 50 kvar	+	+	+	+
	300 kvar	6 x 50 kvar	+	+	+	+
	350 kvar	7 x 50 kvar	+	-	+	+
2,200 mm	400 kvar	8 x 50 kvar	+	-	+	+ ²⁾
	450 kvar	9 x 50 kvar	+	-	+ ²⁾	-
	500 kvar	10 x 50 kvar	+	-	+ ²⁾	-

¹⁾ 14 % choked only possible for 400 V
²⁾ Can only be implemented with degree of protection IP30 / IP31
 Legend:
 + possible
 - not possible

When calculating the required compensation power, you can proceed as follows:

1. The electricity bill of the power supplier shows the consumption of active energy in kWh and reactive energy in kvarh. The distribution system operator (DSO) usually requires a $\cos \varphi$ between 0.90 and 0.95. To avoid costs, the value should be compensated to a $\cos \varphi$ near 1. Where

$$\tan \varphi = \text{reactive energy} / \text{active energy}$$

2. From Tab. 7/4 the conversion factor F must be determined by compensation in dependency of the original value for $\tan \varphi_1$ (row) and the desired $\cos \varphi_2$ (column).

3. The compensation power required is the product of the conversion factor F and the mean active power consumption P_m

$$\text{Compensation power } P_{\text{comp}} = F \times P_m$$

Example:

Reactive energy $W_b = 61.600$ kvarh per month
 Active energy $W_w = 54.000$ kWh per month
 $\tan \varphi_1 = W_b / W_w = 1.14$ ($\cos \varphi_1 = 0.66$)

Mean power consumption P_m
 $P_m = \text{active energy} / \text{working time}$
 $= 54,000 \text{ kWh} / 720 \text{ h}$
 $= 75 \text{ kW}$

Desired power factor $\cos \varphi_2 = 0.95$

Conversion factor F ($\tan \varphi_1 = 1.14$; $\cos \varphi_2 = 0.95$)
 $F = 0.81$

Compensation power $P_{\text{comp}} = F \times P_m = 0.81 \times 75 \text{ kW}$
 $P_{\text{comp}} = 60 \text{ kvar}$

Tab. 7/4: Conversion factors *F* for phase angle adjustments

Actual value given		Conversion factor <i>F</i>										
$\tan \varphi_1$	$\cos \varphi_1$	$\cos \varphi_2 = 0.70$	$\cos \varphi_2 = 0.75$	$\cos \varphi_2 = 0.80$	$\cos \varphi_2 = 0.82$	$\cos \varphi_2 = 0.85$	$\cos \varphi_2 = 0.87$	$\cos \varphi_2 = 0.90$	$\cos \varphi_2 = 0.92$	$\cos \varphi_2 = 0.95$	$\cos \varphi_2 = 0.97$	$\cos \varphi_2 = 1.00$
4.9	0.20	3.88	4.02	4.15	4.20	4.28	4.33	4.41	4.47	4.57	4.65	4.90
3.87	0.25	2.85	2.99	3.12	3.17	3.25	3.31	3.39	3.45	3.54	3.62	3.87
3.18	0.30	2.16	2.30	2.43	2.48	2.56	2.61	2.70	2.75	2.85	2.93	3.18
2.68	0.35	1.66	1.79	1.93	1.98	2.06	2.11	2.19	2.25	2.35	2.43	2.68
2.29	0.40	1.27	1.41	1.54	1.59	1.67	1.72	1.81	1.87	1.96	2.04	2.29
2.16	0.42	1.14	1.28	1.41	1.46	1.54	1.59	1.68	1.74	1.83	1.91	2.16
2.04	0.44	1.02	1.16	1.29	1.34	1.42	1.47	1.56	1.62	1.71	1.79	2.04
1.93	0.46	0.91	1.05	1.18	1.23	1.31	1.36	1.45	1.50	1.60	1.68	1.93
1.83	0.48	0.81	0.95	1.08	1.13	1.21	1.26	1.34	1.40	1.50	1.58	1.83
1.73	0.50	0.71	0.85	0.98	1.03	1.11	1.17	1.25	1.31	1.40	1.48	1.73
1.64	0.52	0.62	0.76	0.89	0.94	1.02	1.08	1.16	1.22	1.31	1.39	1.64
1.56	0.54	0.54	0.68	0.81	0.86	0.94	0.99	1.07	1.13	1.23	1.31	1.56
1.48	0.56	0.46	0.60	0.73	0.78	0.86	0.91	1	1.05	1.15	1.23	1.48
1.40	0.58	0.38	0.52	0.65	0.71	0.78	0.84	0.92	0.98	1.08	1.15	1.40
1.33	0.60	0.31	0.45	0.58	0.64	0.71	0.77	0.85	0.91	1	1.08	1.33
1.27	0.62	0.25	0.38	0.52	0.57	0.65	0.70	0.78	0.84	0.94	1.01	1.27
1.20	0.64	0.18	0.32	0.45	0.50	0.58	0.63	0.72	0.77	0.87	0.95	1.20
1.14	0.66	0.12	0.26	0.39	0.44	0.52	0.57	0.65	0.71	0.81	0.89	1.14
1.08	0.68	0.06	0.20	0.33	0.38	0.46	0.51	0.59	0.65	0.75	0.83	1.08
1.02	0.70	–	0.14	0.27	0.32	0.40	0.45	0.54	0.59	0.69	0.77	1.02
0.96	0.72		0.08	0.21	0.27	0.34	0.40	0.48	0.54	0.63	0.71	0.96
0.91	0.74		0.03	0.16	0.21	0.29	0.34	0.42	0.48	0.58	0.66	0.91
0.86	0.76		–	0.11	0.16	0.24	0.29	0.37	0.43	0.53	0.60	0.86
0.80	0.78			0.05	0.1	0.18	0.24	0.32	0.38	0.47	0.55	0.80
0.75	0.8			–	0.05	0.13	0.18	0.27	0.32	0.42	0.50	0.75
0.70	0.82				–	0.08	0.13	0.21	0.27	0.37	0.45	0.70
0.65	0.84					0.03	0.08	0.16	0.22	0.32	0.40	0.65
0.59	0.86					–	0.03	0.11	0.17	0.26	0.34	0.59
0.54	0.88						–	0.06	0.11	0.21	0.29	0.54
0.48	0.9							–	0.06	0.16	0.23	0.48
0.43	0.92								–	0.10	0.18	0.43
0.36	0.94									0.03	0.11	0.36
0.29	0.96									–	0.01	0.29
0.20	0.98										–	0.20

1
2
3
4
5
6
7
8
9
10
11

7.2 Separately installed compensation cubicles

When compensation cubicles are configured, which are to be installed separated from the switchboard, the back-up

fuse and connecting cable must be factored in. For their configuration data, please refer to Tab. 7/5.

Tab. 7/5: Connecting cables and back-up fuses for separately installed compensation cubicles

Reactive power per cubicle	Nominal voltage 400 V AC / 50 Hz			Nominal voltage 525 V AC / 50 Hz			Nominal voltage 690 V AC / 50 Hz		
	Rated current	Fuse per phase L1, L2, L3	Cable cross section per phase L1, L2, L3	Rated current	Fuse per phase L1, L2, L3	Cable cross section per phase L1, L2, L3	Rated current	Fuse per phase L1, L2, L3	Cable cross section per phase L1, L2, L3
Up to 21 kvar	30.3 A	35 A	10 mm ²	-	-	-	-	-	-
25 kvar	36.1 A	63 A	16 mm ²	27.5 A	50 A	10 mm ²	20.9 A	50 A	10 mm ²
30 kvar	43.3 A	63 A	16 mm ²	-	-	-	-	-	-
35 kvar	50.5 A	80 A	25 mm ²	-	-	-	-	-	-
40 kvar	57.7 A	100 A	35 mm ²	-	-	-	-	-	-
45 kvar	64.9 A	100 A	35 mm ²	-	-	-	-	-	-
50 kvar	72.2 A	100 A	35 mm ²	54.9 A	100 A	35 mm ²	41.8 A	63 A	16 mm ²
60 kvar	86.6 A	160 A	70 mm ²	-	-	-	-	-	-
70 kvar	101 A	160 A	70 mm ²	-	-	-	-	-	-
75 kvar	108 A	160 A	70 mm ²	82.5 A	125 A	35 mm ²	62.7 A	100 A	25 mm ²
80 kvar	115 A	200 A	95 mm ²	-	-	-	-	-	-
100 kvar	144 A	250 A	120 mm ²	110 A	200 A	95 mm ²	83.6 A	125 A	35 mm ²
125 kvar	180 A	300 A	150 mm ²	137 A	200 A	95 mm ²	105 A	160 A	70 mm ²
150 kvar	217 A	355 A	2 x 70 mm ²	165 A	250 A	120 mm ²	126 A	200 A	95 mm ²
160 kvar	231 A	355 A	2 x 70 mm ²	-	-	-	-	-	-
175 kvar	253 A	400 A	2 x 95 mm ²	192 A	300 A	150 mm ²	146 A	250 A	120 mm ²
200 kvar	289 A	500 A	2 x 120 mm ²	220 A	355 A	185 mm ²	167 A	250 A	150 mm ²
250 kvar	361 A	630 A	2 x 150 mm ²	275 A	400 A	2 x 95 mm ²	209 A	315 A	185 mm ²
300 kvar	433 A	2 x 355 A ¹⁾	2 x 185 mm ²	330 A	500 A	2 x 120 mm ²	251 A	400 A	2 x 95 mm ²
350 kvar	505 A	2 x 400 A ¹⁾	4 x 95 mm ^{2 2)}	385 A	630 A	2 x 150 mm ²	293 A	500 A	2 x 120 mm ²
400 kvar	577 A	2 x 500 A ¹⁾	4 x 120 mm ^{2 2)}	440 A	2 x 355 A ¹⁾	2 x 185 mm ²	335 A	500 A	2 x 120 mm ²
450 kvar	650 A	2 x 500 A ¹⁾	4 x 120 mm ^{2 2)}	495 A	2 x 400 A ¹⁾	4 x 95 mm ²	377 A	2 x 315 A ¹⁾	2 x 185 mm ²
500 kvar	722 A	2 x 630 A ¹⁾	4 x 150 mm ^{2 2)}	550 A	2 x 500 A ¹⁾	4 x 120 mm ²	418 A	2 x 315 A ¹⁾	2 x 185 mm ²
600 kvar	866 A	2 x 630 A ¹⁾	4 x 185 mm ^{2 2)}	-	-	-	-	-	-

¹⁾ For this type of protection the information plate "Caution, reverse voltage through parallel cable" is recommended. A circuit-breaker can be used to avoid the problem with parallel fuses.

²⁾ Connection possibility for separately installed compensation cubicles: up to 2 x 240 mm².

Recommendation for 4 parallel cables per phase: Use separate incoming feeder cubicle and power factor correction cubicle with main busbar.

Chapter 8

Further planning notes

8.1	Installation	72
8.2	Weights and power loss	76
8.3	Environmental conditions	77



8 Further planning notes

In the planning stage, installation conditions such as clearances, width of maintenance gangways, weights, underground, as well as environmental conditions, for example climatic conditions, and power loss must already be considered. In particular the following aspects should be kept in mind when planning a switchboard:

- Maximally permitted equipment of a cubicle (for example, number of in-line switch-disconnectors considering size and load; manufacturer specifications must be observed!).
- Minimum cubicle width, considering component density, conductor cross sections and number of cables (a wider terminal compartment may have to be selected or an additional cubicle may have to be configured)
- Device reduction factors must be observed according to manufacturer specifications! Mounting location, ambient temperature and nominal current play an important part (particular attention in case of currents greater than 2,000 A!).
- The dimensioning of compensation systems is very much governed by the location of use (office, production) and the power supply conditions (harmonic content, DSO specifications, audio frequency etc.). Up to about 30 % of the transformer output can be expected as a rough estimate (in industrial environments) in the absence of concrete criteria for planning. If switched-mode power

supply units are increasingly used, for example in ICT equipment in office rooms, the power factor may even turn capacitive. In this context, it must be observed that these power supply units frequently cause system perturbations in the form of harmonics, which can be reduced by passive or active filters.

- The decision in favour of central or distributed implementation of compensation is governed by the network configuration (load center of reactive current sources). In case of distributed arrangement of the compensation systems, appropriate outgoing feeders (in-line switch-disconnectors, circuit-breakers etc.) shall be provided in the switchboard.
- Generator-supplied power systems must not be compensated if problems may arise in generator control as a result of compensation control (disconnecting the compensation system during switch-over to generator mode or static, generator-tuned compensation is possible)
- Choking of a compensation system depends on the power system requirements as well those of the client and the DSO.

8.1 Installation

Installation – clearances and gangway widths

When low-voltage switchboards are installed, the minimum clearances between switchboards and obstacle as specified

by the manufacturer must be observed (Fig. 8/1). The minimum dimensions for operating and maintenance

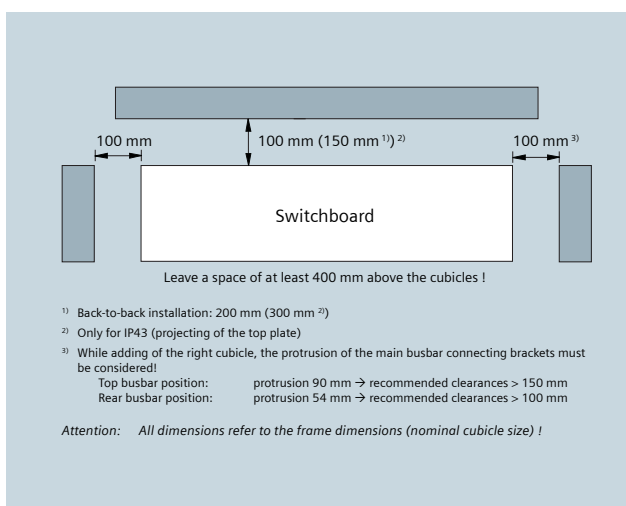

Fig. 8/1: Clearances to obstacles

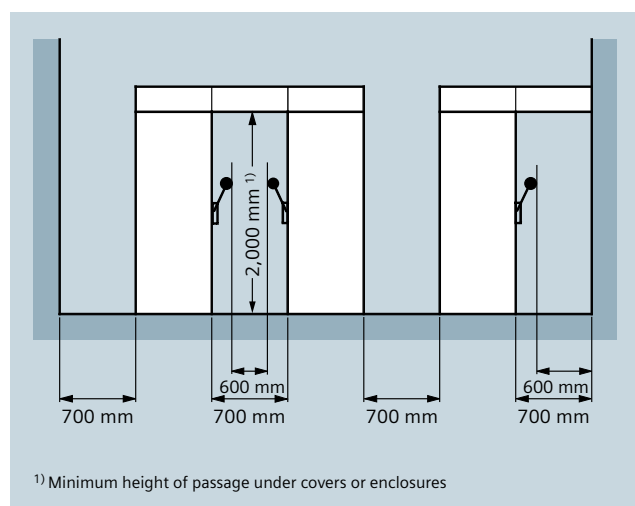

Fig. 8/2: Maintenance gangway widths and passage heights

gangways according to IEC 60364-7-729 must be taken into account when planning the space required (Fig. 8/2). When using a lift truck for the insertion of circuit-breakers, the minimum gangway widths must be matched to the dimensions of the lift truck! Reduced gangway width within the range of open doors must be paid attention to (Fig. 8/3). With opposing switchboard fronts, constriction by open doors is only accounted for on one side. SIVACON S8 doors can be fitted so that they close in escape direction. The door stop can easily be changed later. Moreover, the standard requires a minimum door opening angle of 90°.

Altitude

The altitude of installation must not be above 2,000 m above sea level.

Switchboards and equipment which are to be used in higher altitudes require that the reduction of dielectric strength, the equipment switching capacity and the cooling effect of the ambient air be considered. Further information is available from your Siemens contact.

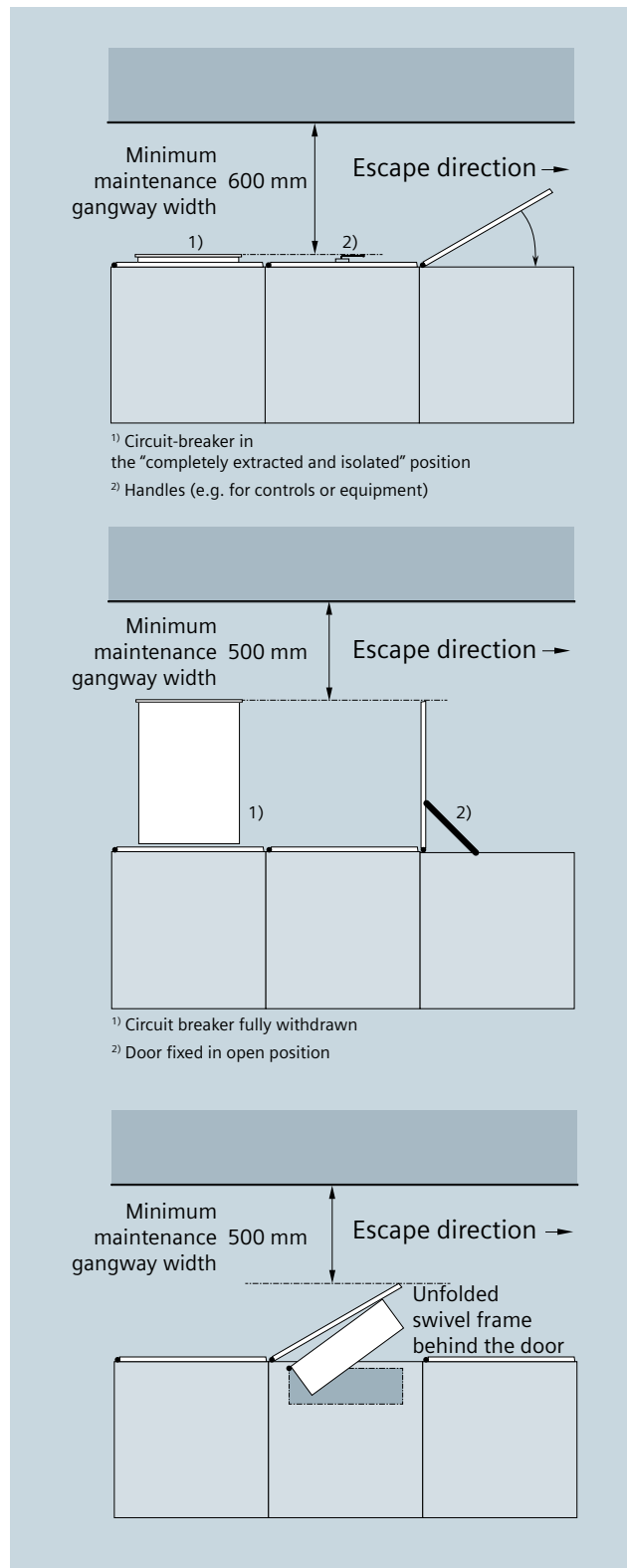
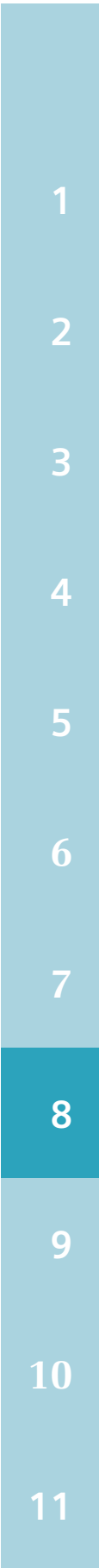

Fig. 8/3: Minimum widths of maintenance gangways in accordance with IEC 60364-7-729



Single-front and double-front systems

In the single-front system, the switchboard cubicles stand next to each other in a row (Fig. 8/4 top). One or more cubicles can be combined into a transport unit. Cubicles within a transport unit have a horizontal through-busbar. Cubicles cannot be separated.

In the double-front system, the cubicles stand in a row next to and behind one another (Fig. 8/4). Double-front systems are only feasible with a rear busbar position. The main feature of a double-front installation is its extremely economical design: the branch circuits on both operating panels are supplied by one main busbar system only.

A double-front unit consists of a minimum of two and a maximum of four cubicles. The width of the double-front unit is determined by the widest cubicle (1) within the double-front unit. This cubicle can be placed at the front or rear side of the double-front unit. Up to three more cubicles (2), (3), (4) can be placed at the opposite side. The sum of the cubicle widths (2) to (4) must be equal to the width of the widest cubicle (1).

One or more double-front units can be combined into a transport unit. Cubicles within a transport unit have a horizontal through-busbar. Cubicles cannot be separated.

Apart from the following exceptions, a cubicle composition within a double-front unit is possible for all designs. The following cubicles determine the width of the double-front unit as cubicle (1) and should only be combined with a cubicle for customized solutions without cubicle busbar system:

- Circuit-breaker design - longitudinal coupler
- Circuit-breaker design - incoming/outgoing feeder 4,000 A, cubicle width 800 mm
- Circuit-breaker design - incoming/outgoing feeder 5,000 A
- Circuit-breaker design - incoming/outgoing feeder 6,300 A

Cubicles with a width of 350 mm or 850 mm are not provided for within double-front systems.

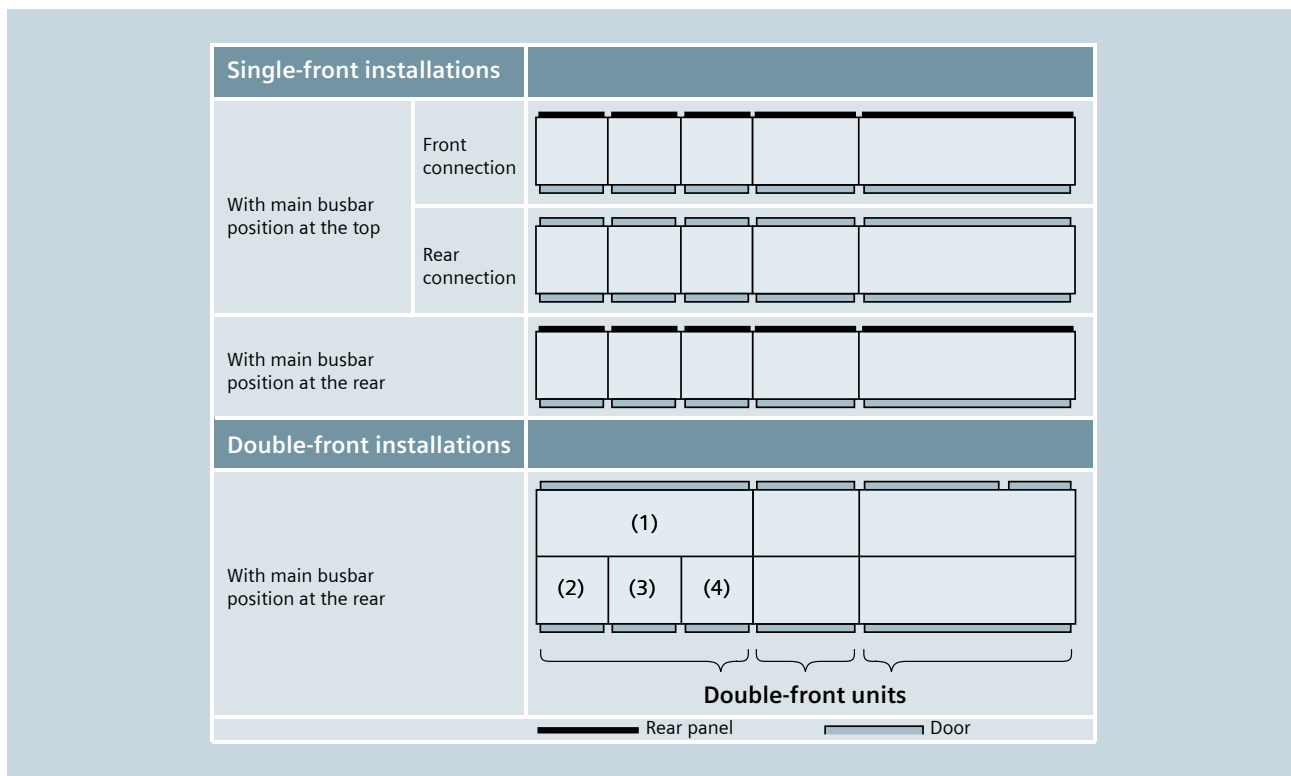

Fig. 8/4: Cubicle arrangement for single-front (top) and double-front systems (bottom)

Foundation frame and floor mounting

The foundation generally consists of concrete, with a cut-out for cable or busbar entry. The cubicles are positioned on a foundation frame made of steel girders. In addition to the permissible deviations of the installation area (Fig. 8/5), it must be ensured that

- The foundation is precisely aligned
- The butt joints of more than one foundation frame are smooth
- The surface of the frame is in the same plane as the surface of the finished floor

Two typical examples for switchboard installation are:

- Installation on a raised floor (Fig. 8/6)
- Foundation frame mounted on concrete (Fig. 8/7)

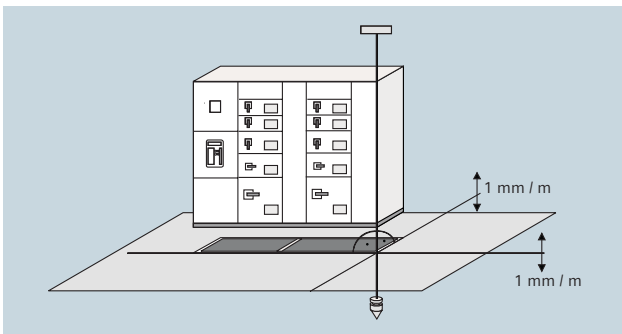

Fig. 8/5: Permissible deviations of the installation area

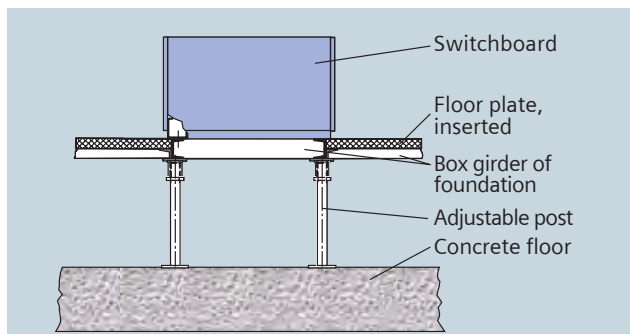

Fig. 8/6: Installation on raised floors

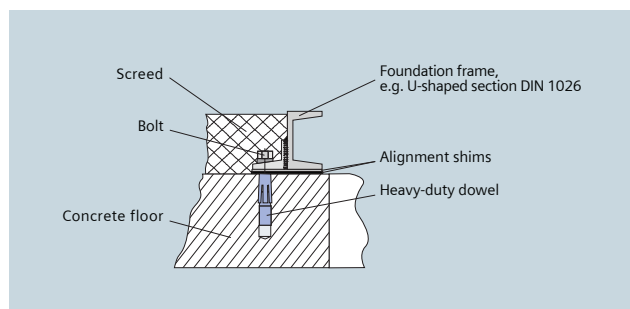

Fig. 8/7: Foundation frame mounted on concrete

For the mounting point on the foundation frame, please see Fig. 8/8 for single-front and Fig. 8/9 for double-front systems. Fig. 8/10 shows dimensions of the corner cubicle. Dimensions in mm are referred to the cubicle widths W and cubicle depth D .

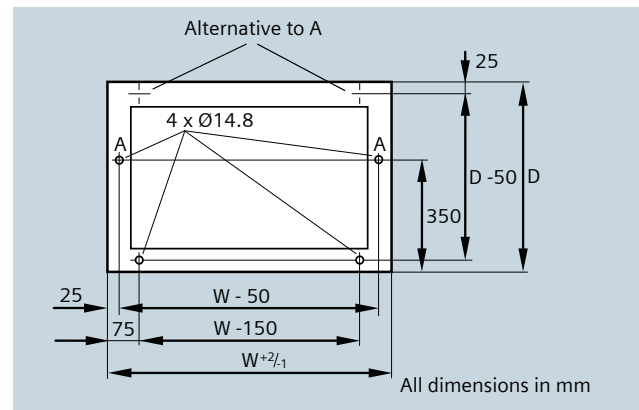

Fig. 8/8: Mounting points of the single-front system

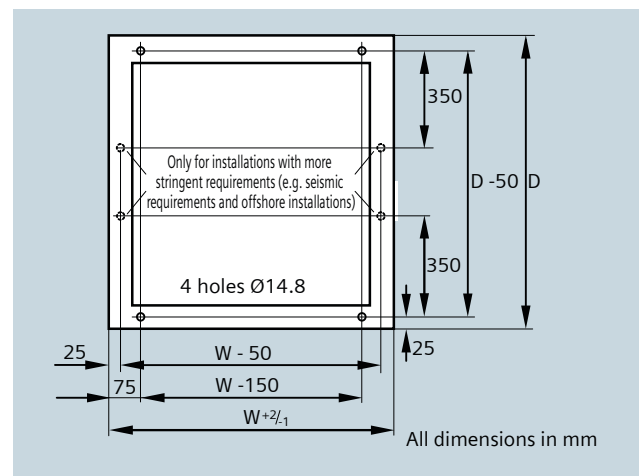

Fig. 8/9: Mounting points of the single-front system

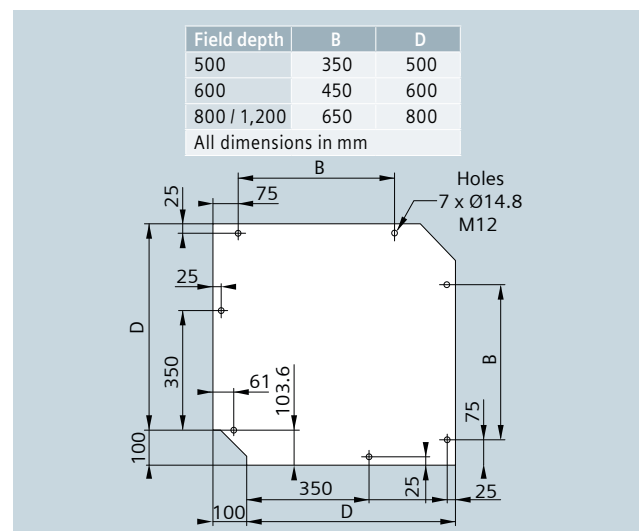

Fig. 8/10: Mounting points for the corner cubicle

8.2 Weights and power loss

Weight data in Tab. 8/1 is for orientation only. The same applies to the power losses specified in Tab. 8/2. This data represents approximate values for a cubicle with the main circuit of functional units for determination of the power loss to be dissipated from the switchboard room. Power

losses of possibly installed additional auxiliary devices must also be taken into consideration. Further information is available from your Siemens contact.

Tab. 8/1: Weights of SIVACON S8 cubicles (orientation values)

Cubicle dimensions			Nominal current	Average weights of the cubicles including busbar (without cable)
Height	Width	Depth		
Circuit-breaker cubicles				
2,200 mm	400 mm	500 mm	630 - 1,600 A	340 kg
	600 mm			390 kg
	600 mm	600 mm	2,000 - 3,200 A	510 kg
	800 mm			545 kg
	800 mm	600 mm	4,000 A	770 kg
		800 mm		
	1,000 mm	800 mm	4,000 - 6,300 A	915 kg
Universal / fixed-mounted design				
2,200 mm	1,000 mm	500 mm		400 kg
		600 mm		470 kg
		800 mm		590 kg
In-line design, fixed-mounted				
2,200 mm	600 mm	600 mm		360 kg
	800 mm	800 mm		470 kg
In-line design, plug-in				
2,200 mm	1,000 mm	500 mm		415 kg
		600 mm		440 kg
		800 mm		480 kg
Reactive power compensation				
2,200 mm	800 mm	500 mm		860 kg
		600 mm		930 kg
		800 mm		1,050 kg

Tab. 8/2: Power losses of SIVACON S8 cubicles (orientation values)

Circuit-breaker design with 3WL (withdrawable unit)	Power loss (approx. value) P_V		Circuit-breaker design with 3VL (withdrawable unit)	Power loss (approx. value) P_V	
	100% rated current	80 % rated current		100% rated current	80 % rated current
3WL1106 (630 A, Bg. I)	215 W	140 W	3VL630 (630 A)	330 W	210 W
3WL1108 (800 A, Bg. I)	345 W	215 W	3VL800 (800 A)	440 W	290 W
3WL1110 (1,000 A Bg. I)	540 W	345 W	3VL1250 (1,250 A)	700 W	450 W
3WL1112 (1,250 A, Bg. I)	730 W	460 W	3VL1600 (1,600 A)	1,140 W	730 W
3WL1116 (1,600 A, Bg. I)	1,000 W	640 W	Fixed-mounted design	$P_V = \text{approx. } 600 \text{ W}$	
3WL1220 (2,000 A, Bg. II)	1,140 W	740 W	In-line design, fixed-mounted	$P_V = \text{approx. } 600 \text{ W}$	
3WL1225 (2,500 A, Bg. II)	1,890 W	1,210 W	In-line design, plug-in	$P_V = \text{approx. } 1,500 \text{ W}$	
3WL1232 (3,200 A, Bg. II)	3,680 W	2,500 W	Withdrawable-unit design	$P_V = \text{approx. } 600 \text{ W}$	
3WL1340 (4,000 A, Bg. III)	4,260 W	2,720 W	Reactive power compensation	Power loss (approx. value) P_V	
3WL1350 (5,000 A, Bg. III)	5,670 W	3,630 W	Non-choked	1.4 W/kvar	
3WL1363 (6,300 A, Bg. III)	8,150 W	5,220 W	Choked	6.0 W/kvar	

8.3 Environmental conditions

The climate and other external conditions (natural foreign substances, chemically active pollutants, small animals) may affect the switchboard to a varying extent. The influence depends on the air-conditioning equipment of the switchboard room.

According to IEC 61439-1, environmental conditions for low-voltage switchboards are classified as:

- Normal service conditions (IEC 61439-1, section 7.1)
- Special service conditions (IEC 61439-1, section 7.2)

SIVACON S8 switchboards are intended for use in the normal environmental conditions described in Tab. 8/3.

If special service conditions prevail (Tab. 8/4), special agreements between the switchboard manufacturer and the user must be reached. The user must inform the switchboard manufacturer about such extraordinary service conditions.

Special service conditions relate to the following, for example:

- Data about ambient temperature, relative humidity and/or altitude if this data deviates from the normal service conditions

- The occurrence of fast temperature and/or air pressure changes, so that extraordinary condensation must be expected inside the switchboard
- An atmosphere which may contain a substantial proportion of dust, smoke, corrosive or radioactive components, vapours or salt (e.g. H₂S, NO_x, SO₂, chlorine)

The occurrence of severe concussions and impacts is considered in the section Chapter 9.3 "Seismic safety and seismic requirements".

In case of higher concentrations of pollutants (Class > 3C2) pollutant reducing measures are required, for example:

- Air-intake for service room from a less contaminated point
- Expose the service room to slight excess pressure (e.g. injecting clean air into the switchboard)
- Air conditioning of switchboard rooms (temperature reduction, relative humidity < 60%, if necessary, use pollutant filters)
- Reduction of temperature rise (oversizing of switching devices or components such as busbars and distribution bars)

Further information is available from your Siemens contact.

Tab. 8/3: Normal service conditions for SIVACON S8 switchboards

Environmental conditions	Class	Environmental parameters including their limit values (Definition acc. to IEC 60721-3-3)		Measures
Climatic	3K4	Low air temperature	-5 °C ^{1),3)}	
		High air temperature	+40 °C ³⁾ +35 °C (24 h mean) ^{2),3)}	
		Low relative humidity	5 %	
		High relative humidity	95 %	
		Examples for relation (air temperature - air humidity)	at 40 °C: 50 % ³⁾ at 20 °C: 90 % ³⁾	
		Low absolute humidity	1 g/m ³	
		High absolute humidity	29 g/m ³	
		Speed of temperature change	0.5 °C min.	
		Low air pressure	70 kPa	
		High air pressure	106 kPa	
		Sunlight	700 W/m ²	
		Heat radiation	None	
		Condensation	possible	Install switchboard heating
		Wind-borne precipitation	No	
		Water (except rain)	See special service conditions	
Ice formation	No			

1) According to IEC 60721-3-3, a minimum temperature of +5 °C is permissible.
2) Higher values are permissible on request
3) Data in accordance with IEC 61439-1; any other, not identified values in accordance with IEC 60721-3-3

Tab. 8/4: Special service conditions for SIVACON S8 switchboards

Environmental conditions	Class	Environmental parameters including their limit values (Definition acc. to IEC 60721-3-3)		Measures	
Chemically active substances	3C2	Sea salt	Presence of salt mist		on request
			Mean value	Limiting value	
		Sulphur dioxide SO ₂	0.3 mg/m ³	1.0 mg/m ³	
		Hydrogen sulphide H ₂ S	0.1 mg/m ³	0.5 mg/m ³	
		Chlorine Cl ₂	0.1 mg/m ³	0.3 mg/m ³	
		Hydrogen chloride HCl	0.1 mg/m ³	0.5 mg/m ³	
		Hydrogen fluoride	0.01 mg/m ³	0.03 mg/m ³	
		Ammonia NH ₃	1.0 mg/m ³	3.0 mg/m ³	
		Ozone O ₃	0.05 mg/m ³	0.1 mg/m ³	
		Nitrogen oxides NO _x	0.5 mg/m ³	1.0 mg/m ³	
Additional climatic environmental conditions	3Z1	Heat radiation is negligible			
	3Z7	Dripping water in accordance with IEC 60068-2-18		IPX1	
	3Z9	Splashing water in accordance with IEC 60068-2-18		IPX4	
	3B2	Flora	Presence of mould, fungus, etc.		≥ IP4X including protection of the cable basement
		Fauna	Presence of rodents and other animals harmful to products, excluding termites		
Mechanically active substances	3S1	Sand in air	-		< IP5X
		Dust (suspension)	0.01 mg/m ³		
		Dust (sedimentation)	0.4 mg/(m ³ ·h)		
	3S2	Sand in air	300 mg/m ³		≥ IP5X
		Dust (suspension)	0.4 mg/m ³		
		Dust (sedimentation)	15 mg/(m ³ ·h)		

Conditions for transport, storage and installation

If the ambient conditions for transport, storage or switchboard installation deviate from the normal service conditions listed in Tab. 8/4 (for example an excessively low or high value for temperature or air humidity), the measures

required for proper treatment of the switchboard must be agreed upon between manufacturer and client.



Chapter 9

Conforming to standards and design-tested

9.1	The product standard IEC 61439-2	80
9.2	Arc resistance	81
9.3	Seismic safety and seismic requirements	83
9.4	Declarations of conformity and certificates	85

9 Conforming to standards and design-verified

9.1 The product standard IEC 61439-2

Low-voltage switchboards, or "power switchgear and controlgear assemblies" according to the standard, are developed and manufactured according to the specifications of IEC 61439-2 and their compliance with the standard is verified. To prove the suitability of the switchboard, this standard requires two essential types of verification – design verification and routine verification. Design verifications are tests accompanying development, which must be performed by the original manufacturer (designer). Routine verifications must be performed by the manufacturer of the power switchgear and controlgear assembly (switchboard manufacturer) on every manufactured switchboard prior to delivery.

Design verification test

The SIVACON S8 switchboard ensures safety for man and machine by means of design verification (Tab. 9/1) by testing in accordance with IEC 61439-2. Its physical properties are rated in the test area both for operating and fault conditions and ensure maximum personal safety and system protection. These design verifications and routine

verifications are a pivotal part of quality assurance and constitute the pre-requisite for CE marking in accordance with EC Directives and legislation.

Verification of temperature rise

One of the most important verification procedures is the "verification of temperature rise". In this procedure, the switchboard's suitability for temperature rises owing to power loss is verified. Because of ever rising current ratings and concurrently increasing requirements of degree of protection and internal separation, this is one of the greatest challenges switchboards are confronted with. According to the standard, this verification can be performed by calculation up to a rated current of 1,600 A. For SIVACON S8, this verification is always performed by testing. Rules for the selection of test pieces (worse case test) and the testing of complete assemblies ensure that the entire product range is systematically covered and that this verification always includes the associated devices. This means that testing randomly selected test pieces suffices no less than replacing a device without repeating the test.

Tab. 9/1: Test for the design verification in accordance with IEC 61439-2

The table shows all verifications required by the standard . They can be delivered by three alternative possibilities.	Verification by testing	Verification by calculation	Verification by design rules
1. Strength of solid matters and components	✓	-	-
2. Degree of protection of enclosures	✓	-	✓
3. Creepage distances and clearances	✓	✓	✓
4. Protection against electric shock and integrity of protective circuits	✓	✓ ¹⁾	✓ ¹⁾
5. Incorporating equipment	-	-	✓
6. Internal electric circuits and connections	-	-	✓
7. Connections for conductors entered from the outside	-	-	✓
8. Dielectric properties	✓	-	✓ ²⁾
9. Temperature rise limits	✓	up to 1,600 A	up to 630 A ³⁾
10. Short-circuit strength	✓	Conditional ³⁾	Conditional ³⁾
11. Electromagnetic compatibility (EMC)	✓	-	✓
12. Mechanical function	✓	-	-

¹⁾ Effectivity of the assembly in case of external faults
²⁾ Only impulse withstand voltage
³⁾ Comparison with an already tested design

9.2 Arc resistance

An internal arc is one of the most dangerous faults inside switchboards with extremely serious consequences – in particular because personal safety is affected. Internal arcs may be caused by wrong rating, decreasing insulation, pollution as well as handling mistakes. Their effects, caused by high pressure and extremely high temperatures, can have fatal consequences for the operator and the system which may even extend to the building.

An arc-resistant assembly consists of arc-free and/or arc-resistant zones. An arc-free zone is defined as part of a circuit within the assembly where it is not possible to apply an igniter wire without destroying the insulating material of the conductors, in the insulated main busbar for SIVACON S8, for example (Fig. 9/1). An arc-resistant zone is defined as part of a circuit where an igniter wire can be applied and which fulfils all applicable criteria for test assessment, such as the main busbar compartment of the SIVACON S8 with arc barriers (Fig. 9/2). If the assembly is supplied by a transformer, an arc duration of 300 ms should be considered in order to enable disconnection by a high-voltage protection device.

The test of low-voltage switchboards under arcing conditions is a special test in accordance with IEC/TR 61641. For SIVACON S8 low-voltage switchboards, personal safety was verified by testing under arcing conditions.

Active and passive protective measures prevent internal arcs and thus personal injury or limit their effects within the switchboard:

- Insulation of live parts (e.g. busbars)
- Uniform user interfaces and displays with integrated operating error protection
- Reliable switchboard dimensioning
- Arc-resistant hinge and lock systems
- Safe operating (moving) of withdrawable units or circuit-breakers behind closed door
- Protective measures in air vents
- Arc barriers
- Arc detection systems combined with fast disconnection on internal arcs

The effectivity of the measures described is proven by countless, comprehensive arcing fault tests under "worst case" conditions performed on a great variety of cubicle types and functional units.

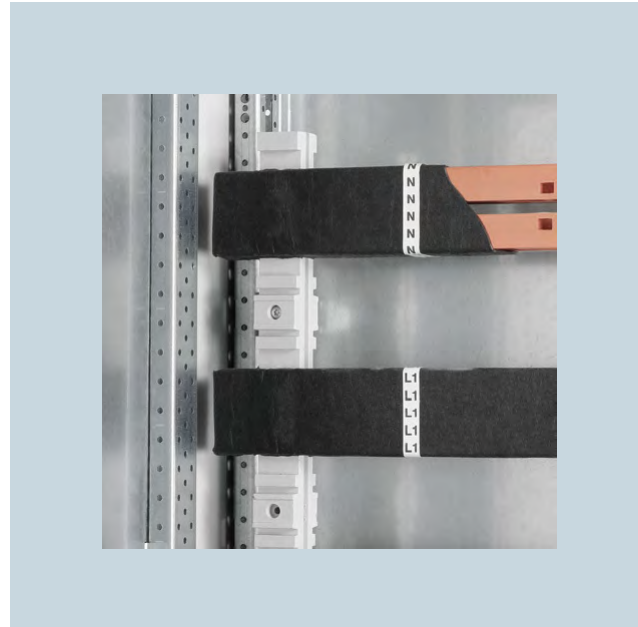

Fig. 9/1: Insulated main busbar in the SIVACON S8 (optional N insulation)

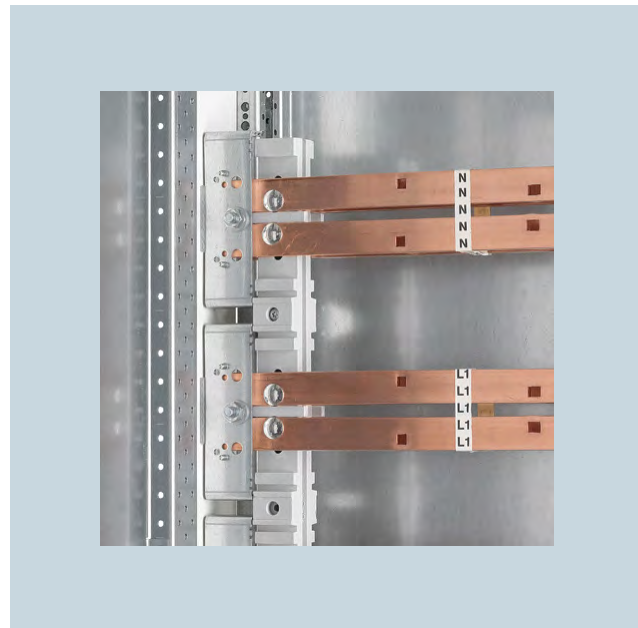

Fig. 9/2: Arc barrier in SIVACON S8

1

2

3

4

5

6

7

8

9

10

11

System characteristics under arcing conditions

The following data must be provided by the assembly manufacturer:

- Rated operating voltage U_e
- Permissible short-circuit current under arcing conditions $I_{p,arc}$ and the associated permissible arcing time t_{arc} or
- Permissible conditional short-circuit current under arcing conditions $I_{pc,arc}$

Corresponding characteristics for SIVACON S8 are given in Tab. 9/2.

In addition, to include system protection, the defined areas (e.g. cubicle, compartment) must be given to which the effects of the internal arc shall be limited. The properties of current-limiting devices (e.g. current-limiting circuit-breakers or fuses) which are required for circuit protection must be specified if applicable.

Assessment criteria for personal safety and system protection

Personal safety is ensured if the following five criteria are fulfilled:

1. Properly secured doors, covers, etc., must not open.
2. Parts (of the assembly) that are potentially hazardous must not fly off.
3. The impact of an internal arc must not produce any holes in the freely accessible outer parts of the enclosure as a result of burning or other effects.
4. Vertically applied indicators must not ignite.
5. The PE circuit for parts of the enclosure that can be touched must still be functional.

System protection is ensured if the five above-mentioned criteria are fulfilled plus criterion 6.

6. The internal arc must be limited to a defined area and there will be no re-ignition in adjacent areas.

Suitability for restricted continued service (additional criterion 7):

7. Emergency operation of the assembly must be possible after the fault has been rectified and affected functional units were disconnected or removed. This must be verified by an insulation test with 1.5 times the value of the rated operating voltage for the duration of one minute.

Tab. 9/2: SIVACON S8 system characteristics under arcing conditions

Rated operating voltage U_e	Up to 690 V
Prospective short-circuit current under arcing conditions $I_{p,arc}$	Up to 100 kA
Arcing time t_{arc}	Up to 300 ms

The arcing concept of SIVACON S8

Siemens has developed a graded concept which comprises the requirements of arc resistance SIVACON S8 may be subjected to. The arc levels (Tab. 9/3) describe the limitation of effects of an internal arc on the system or system components of the SIVACON S8.

Tab. 9/3: SIVACON S8 arc levels (system areas to which the internal arc is limited are marked in orange)

<p>Level 1</p> <p>Personal safety without extensive limitation of the arcing fault effects within the installation.</p>	
<p>Level 2</p> <p>Personal safety with limitation of the arcing fault effects to one cubicle or double-front unit.</p>	
<p>Level 3</p> <p>Personal safety with limitation of the arcing fault effects to the main busbar compartment, to the device compartment or to the cable compartment in one cubicle or double-front unit.</p>	
<p>Level 4</p> <p>Personal safety with limitation of the arcing fault effects to the place of origin.</p>	

9.3 Seismic safety and seismic requirements

The SIVACON S8 switchboard is available in earthquake-proof design for seismic requirements. The tests examine its operability and stability during and after an earthquake. As illustrated in Tab. 9/4, the results of the earthquake tests are specified for three categories.

Test specifications

- IEC 60068-3-3, German version from 1993: Environmental testing; Seismic test methods for equipments – Guidance
- IEC 60068-2-6, German version from 2008: Environmental testing; Tests – Test Fc: Vibrations, sinusoidal
- IEC 60068-2-57, German version from 2000: Environmental testing; Tests – Test Ff: Vibrations – Time-history and sine-beat method
- KTA 2201.4, 2000: Design of Nuclear Power Plants against Seismic Events
- IEC 60980, 1989: Recommended practices for seismic qualification of electrical equipment of the safety system for nuclear generating stations
- UBC, Uniform Building Code, 1997: Chapter 16, Division IV

Testing is performed in three axes with independently generated time histories in three axes in accordance with IEC 60068-2-57.

Tab. 9/4: SIVACON S8 system characteristics under earthquake conditions

Category 1: Operability during the earthquake	$\alpha_f = 0.6 \text{ g (ZPA)}$
Category 2: Operability after the earthquake	$\alpha_f = 0.75 \text{ g (ZPA)}$
Category 3: Stability	$\alpha_f = 1.06 \text{ g (ZPA)}$
α_f = floor acceleration (acceleration in the mounting plane of the switchboard) ZPA = zero period acceleration g = ground acceleration = 9.81 m/s^2	

Acceleration values

There is a simple interrelation between storey acceleration α_f and local ground acceleration α_g :

$$\alpha_f = K \times \alpha_g$$

with amplification factor K according to Tab. 9/5. Ground acceleration depends on the local seismic conditions.

If the switchboard is installed at ground level and directly on the ground-level foundation, this acceleration factor – provided that there are no further specifications – can be regarded as the acceleration which acts on the mounting plane of the switchboard ($K = 1, \alpha_f = \alpha_g$).

Depending on how the switchboard is fastened, an amplification of the ground acceleration becomes effective. This dependency is taken into account with the amplification factor K (Tab. 9/5).

If there is no information about the storey acceleration or the installation of the switchboard, $K = 2$ is applied, meaning double the value of the specified ground acceleration is regarded as the stress the switchboard will be exposed to.

If there are no specifications regarding the directional assignment of the acceleration parameters, the values are referred to the horizontal directions (x, y). Conforming to international standards, the vertical accelerations are lower and are usually factored in with 0.5 to 0.6 times the horizontal acceleration.

Tab. 9/5: Acceleration factor K for SIVACON S8

K factor	Fastening of the switchboard
1.0	On rigid foundations or supporting structure of high stiffness
1.5	Rigidly connected with the building
2.0	On stiff supporting structure which is rigidly connected with the building
3.0	On supporting structure of low stiffness, connected to the building

Comparison of seismic requirements

There are numerous international and national standards referring to the classification of seismic requirements. Classification varies greatly in these documents. For this reason, the specification of an earthquake zone always requires reference to the relevant standard or classification. With regard to the requirements placed on SIVACON S8 switchboards, it is therefore advantageous to specify the floor acceleration. Or, if this information is not available, the ground acceleration in the vicinity of the building accommodating the installation should be given. Fig. 9/3 shows the relation of the seismic categories 1, 2 and 3 from Tab. 9/4 to the known earthquake classifications and seismic scale divisions

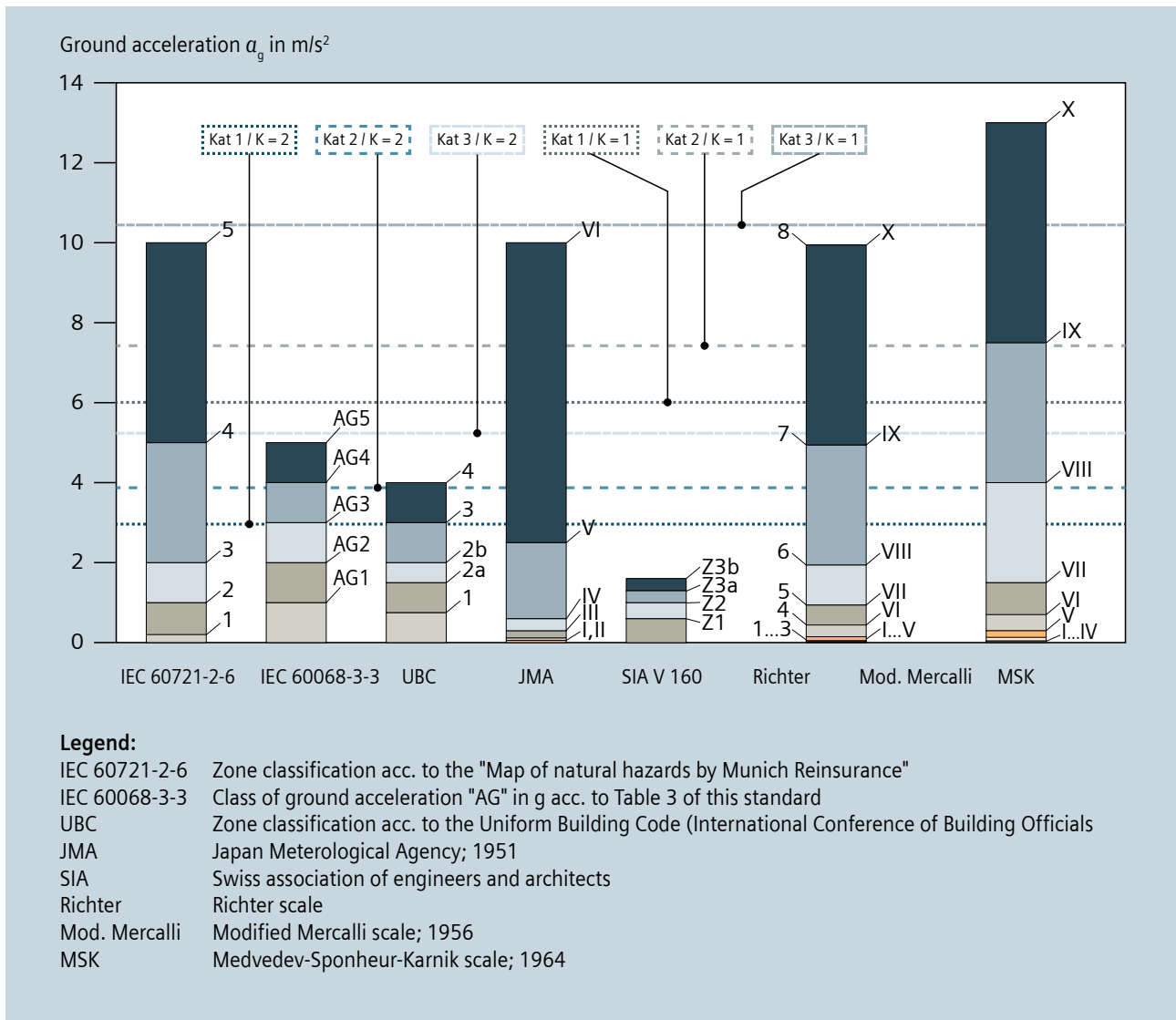

Fig. 9/3: Comparison of seismic scales for the classification of seismic response categories of SIVACON S8

9.4 Declarations of conformity and certificates

With a Declaration of Conformity, the manufacturer of the low-voltage switchboard confirms that the requirements of the directive or standard referred to in this declaration have been fulfilled.

Further information about such declarations of conformity and certificates (Fig. 9/4, and Fig. 9/5 to Fig. 9/7 are examples of such documents) can be obtained from your Siemens contact.

CE marking / EC declaration of conformity

The CE marking is a label affixed under the sole responsibility of the manufacturer. The Declaration of Conformity confirms compliance of products with the relevant basic requirements of all EU Directives of the European Union (European Community, EC) applicable to this product.

Low-voltage switchboards – named power switchgear and controlgear assemblies in the product standard IEC 61439-2 – must comply with the requirements of the Low Voltage Directive 2006/95/EC and the EMC Directive 2004/108/EC. The CE marking is a mandatory condition for placing products on the markets of the entire European Union.

The new Low Voltage Directive 2014/35/EU and EMC Directive 2014/30/EU must be transferred in national law by the EU member states up to the 20th of April, 2016. At that time a new declaration of conformity is provided.

1

2

3

4

5

6

7

8

9

10

11

EG-Konformitätserklärung / EC-Declaration of Conformity

Nr./No. EC 0002.03de

Hersteller: Siemens AG / IC LMV MS
 Manufacturer
 Anschrift: Mozartstrasse 31 C
 Address: D-91052 Erlangen

Produktbezeichnung: Niederspannungs-Schaltgerätekombination SIVACON S8
 Product identification: Low-voltage switchgear and controlgear assembly SIVACON S8

Das bezeichnete Produkt entspricht in der gelieferten Ausführung den Bestimmungen folgender EU-Richtlinie(n):

2006/95/EG RICHTLINIE DES EUROPÄISCHEN PARLAMENTS UND DES RATES vom 12. Dezember 2006 zur Angleichung der Rechtsvorschriften der Mitgliedstaaten betreffend elektrische Betriebsmittel zur Verwendung innerhalb bestimmter Spannungsgrenzen

2004/108/EG RICHTLINIE DES EUROPÄISCHEN PARLAMENTS UND DES RATES vom 15. Dezember 2004 zur Angleichung der Rechtsvorschriften der Mitgliedstaaten über die elektromagnetische Verträglichkeit

The designated product as delivered is in conformity with the provisions of the following EU-Directive(s):

2006/95/EC DIRECTIVE OF THE EUROPEAN PARLIAMENT AND OF THE COUNCIL of 12 December 2006 on the harmonisation of the laws of Member States relating to electrical equipment designed for use within certain voltage limits

2004/108/EC DIRECTIVE OF THE EUROPEAN PARLIAMENT AND OF THE COUNCIL of 15 December 2004 on the approximation of the laws of the Member States relating to electromagnetic compatibility

Anbringung der CE-Kennzeichnung seit / affixing of the CE-marking since: 07

Die Übereinstimmung des bezeichneten Produkts mit den Vorschriften der angewandten Richtlinie(n) wird nachgewiesen durch die vollständige Einhaltung folgender Normen / Vorschriften:

The conformity of the designated product with the provisions of the applied Directive(s) is proved by full compliance with the following standards / regulations:

Harmonisierte Normen, sonstige technische Normen, Spezifikationen / Harmonised standards, other technical standards, specifications:

Referenznummer Reference number	Ausgabedatum Date of issue	Referenznummer Reference number	Ausgabedatum Date of issue
EN 61439-2	2011	VDE 0660-600-2	Juni 2012
IEC 61439-2 Ed. 2.0	2011-08		

Siemens Aktiengesellschaft

Leipzig 14.01.2014
 Ort / place of issue Datum / Date of issue

Franke
 Name / name Unterschrift / signature

Head IC LMV MS R&D LVS
 Funktion / function

Ulbrich
 Name / name Unterschrift / signature

Head IC LMV MS S PLM SB
 Funktion / function

Diese Erklärung bescheinigt die Übereinstimmung mit den genannten Richtlinien, ist jedoch keine Beschaffenheits- oder Haltbarkeitsgarantie. Die Sicherheitshinweise der mitgelieferten Produktdokumentation sind zu beachten.

This declaration certifies the compliance with the indicated directives but does not imply any warranty for properties. The safety instructions of the accompanying product documentation shall be observed.

Siemens Aktiengesellschaft: Vorsitzender des Aufsichtsrats: Gerhard Cromme; Vorstand: Joe Kaeser, Vorsitzender; Roland Busch, Klaus Helmrich, Hermann Requardt, Siegfried Russwurm, Michael Süß, Ralf P. Thomas
 Sitz der Gesellschaft: Berlin und München, Deutschland; Registergericht: Berlin Charlottenburg, HRB 12300, München, HRB 6684
 WEEE-Reg.-Nr. DE 23691322

Fig. 9/4: EC-Declaration of Conformity for SIVACON S8 in respect of the Low Voltage and EMC Directives

SIEMENS

Konformitätserklärung

Declaration of Conformity

Nr. **EK 0030.00de**
No.

Siemens AG / IC LMV MS

Wir _____
We (Name des Herstellers / manufacturer's name)

Mozartstrasse 31 C
D-91052 Erlangen

(Anschrift / address)

erklären in alleiniger Verantwortung, daß das (die) Produkt(e)
declare under our sole responsibility that the product(s)

SIVACON S8
Niederspannungs-Schaltgerätekombination
SIVACON S8
Low-voltage switchgear and controlgear assembly

(Bezeichnung, Typ oder Modell /
name, type or model)

mit folgenden normativen Dokumenten übereinstimmt (übereinstimmen);
is (are) in conformity with the following normative documents:

IEC 61439-2 Edition 2.0 2011-08
EN 61439-2:2011
VDE 0660-600-2 Juni 2012

(Titel und/oder Nr. sowie Ausgabedatum odes normativen Dokumentes /
Title and/or number and date of issue of the normative document)

Bauartnachweise nach Kapitel 10 der oben
genannten Normen (siehe Anlage)
Design verifications according to chapter 10 of the above
mentioned standards (see annex)

Diese Konformitätserklärung entspricht der Europäischen Norm EN ISO/IEC 17050-1 "Konformitätsbewertung - Konformitätserklärung von Anbietern - Teil 1: Allgemeine Anforderungen". Diese Erklärung bescheinigt die Übereinstimmung des Produktes in der von uns in Verkehr gebrachten Ausführung mit den genannten Richtlinien, ist jedoch keine Beschaffenheits- oder Haltbarkeitsgarantie nach §443 BGB. Die Sicherheitshinweise der mitgelieferten Produktdokumentation sind zu beachten.

This Declaration of Conformity is in compliance with the European Standard EN ISO/IEC 17050-1 "Conformity assessment - Supplier's declaration of conformity - Part 1: General requirements". This declaration certifies the conformity of the product as delivered to the specified directives but does not imply any warranty for properties. The safety instructions of the accompanying product documentation shall be observed.

Siemens Aktiengesellschaft

Leipzig 14.01.2014
Ort / place of issue Datum / Date of issue

Franke _____
Name / name Unterschrift / signature

Ulbrich _____
Name / name Unterschrift / signature

Head IC LMV MS R&D LVS
Funktion / function

Head IC LMV MS S PLM SB
Funktion / function

Siemens Aktiengesellschaft: Vorsitzender des Aufsichtsrats: Gerhard Cromme; Vorstand: Joe Kaeser, Vorsitzender; Roland Busch, Klaus Heinrich, Hermann Requardt, Siegfried Russwurm, Michael Süß, Ralf P. Thomas
Sitz der Gesellschaft: Berlin und München, Deutschland; Registergericht: Berlin Charlottenburg, HRB 12300, München, HRB 6684
WEEE-Reg.-Nr. DE 23691322

045123041 5000001 09 171231

Fig. 9/5: Declaration of Conformity for SIVACON S8 regarding design verification

Anlage zur Konformitätserklärung

Annex to Declaration of Conformity

Nr. **EK 0030.00de**
No.

Seite **1/2**
Page

Durchgeführte Bauartnachweise nach IEC 61439-2 / EN 61439-2 / VDE 0660-600-2:
Design verifications performed according to IEC 61439-2 / EN 61439-2 / VDE 0660-600-2:

10.2.2	Korrosionsbeständigkeit Resistance to corrosion
10.2.3.2	Nachweis der Widerstandsfähigkeit von Isolierstoffen gegen außergewöhnliche Wärme und Feuer aufgrund von inneren elektrischen Wirkungen Verification of the resistance of insulating materials to abnormal heat and fire due to internal electric effects
10.2.5	Anheben Lifting
10.2.6	Schlagprüfung Mechanical impact
10.2.7	Aufschriften Marking
10.3	Schutzart von Gehäusen Degree of protection of ASSEMBLIES
10.4	Luft- und Kriechstrecken Clearances and creepage distances
10.5.2	Durchgängigkeit der Verbindung zwischen Körpern der Schaltgerätekombination und Schutzleiterkreis Effective earth continuity between the exposed conductive parts of the ASSEMBLY and the protective circuit
10.5.3	Kurzschlussfestigkeit des Schutzleiterkreises Short-circuit withstand strength of the protective circuit
10.6	Einbau von Betriebsmitteln Incorporation of switching devices and components
10.7	Innere elektrische Stromkreise und Verbindungen Internal electrical circuits and connections
10.8	Anschlüsse für von außen eingeführte Leiter Terminals for external conductors
10.9.2	Betriebsfrequente Spannungsfestigkeit Power-frequency withstand voltage
10.9.3	Stoßspannungsfestigkeit Impulse withstand voltage
10.10	Nachweis der Erwärmung Verification of temperature rise
10.11	Kurzschlussfestigkeit Short-circuit withstand strength
10.12	Elektromagnetische Verträglichkeit (EMV) Electromagnetic compatibility (EMC)
10.13	Mechanische Funktion Mechanical operation

Fig. 9/6: Declaration of Conformity for SIVACON S8 regarding design verification - Annex Page 1/2

Anlage zur Konformitätserklärung

Annex to Declaration of Conformity

Nr. **EK 0030.00de**
No.

Seite **2/2**
Page

Anmerkungen: Remarks:

Die einzelnen Nachweise sind jeweils in einem Typprüfbericht dokumentiert. Diese Typprüfberichte liegen beim Hersteller vor.

Each of the individual verifications is documented in a type test report. These type test reports are available at the manufacturer.

Nachweise der Wärmebeständigkeit von Gehäusen nach Kapitel 10.2.3.1 sind nur für Gehäuse aus Isolierstoffen erforderlich. Die Gehäuse von SIVACON S8 bestehen aus beschichtetem Stahlblech.

Verification of the thermal stability of enclosures according to clause 10.2.3.1 is only required for enclosures manufactured from insulating material. The enclosures of SIVACON S8 are manufactured from coated sheet steel.

Nachweise der Beständigkeit gegen ultra-violette (UV-)Strahlung nach Kapitel 10.2.4 sind nur für Gehäuse für Freiluftaufstellung erforderlich. SIVACON S8 ist ausschließlich für Innenraumaufstellung vorgesehen.

Verification of the resistance to ultra-violet (UV) radiation according to clause 10.2.4 is only required for enclosures intended to be installed outdoors. SIVACON S8 is only intended for indoor installations.

EMV-Prüfungen sind nicht erforderlich, wenn die Anforderungen der oben genannten Normen, Abschnitt J.9.4.2 a) und b), eingehalten werden.

No EMC tests are required if the conditions of clause 8.2.8 a) and b) of the above mentioned standards are fulfilled.

Siemens Aktiengesellschaft

Leipzig 14.01.2014
Ort / place of issue Datum / Date of issue

Franke
Name / name Unterschrift / signature

Head IC LMV MS R&D LVS
Funktion / function

Ulbrich
Name / name Unterschrift / signature

Head IC LMV MS S PLM SB
Funktion / function

Siemens Aktiengesellschaft: Vorsitzender des Aufsichtsrats: Gerhard Cromme; Vorstand: Joe Kaeser, Vorsitzender; Roland Busch, Klaus Helmrich, Hermann Requardt, Siegfried Rusowurm, Michael Süß, Ralf P. Thomas
Sitz der Gesellschaft: Berlin und München, Deutschland; Registergericht: Berlin Charlottenburg, HRB 12300, München, HRB 6684
WEEE-Reg.-Nr. DE 23691322

481000000 500 000 11 08 10122

Fig. 9/7: Declaration of Conformity for SIVACON S8 regarding design verification - Annex Page 2/2

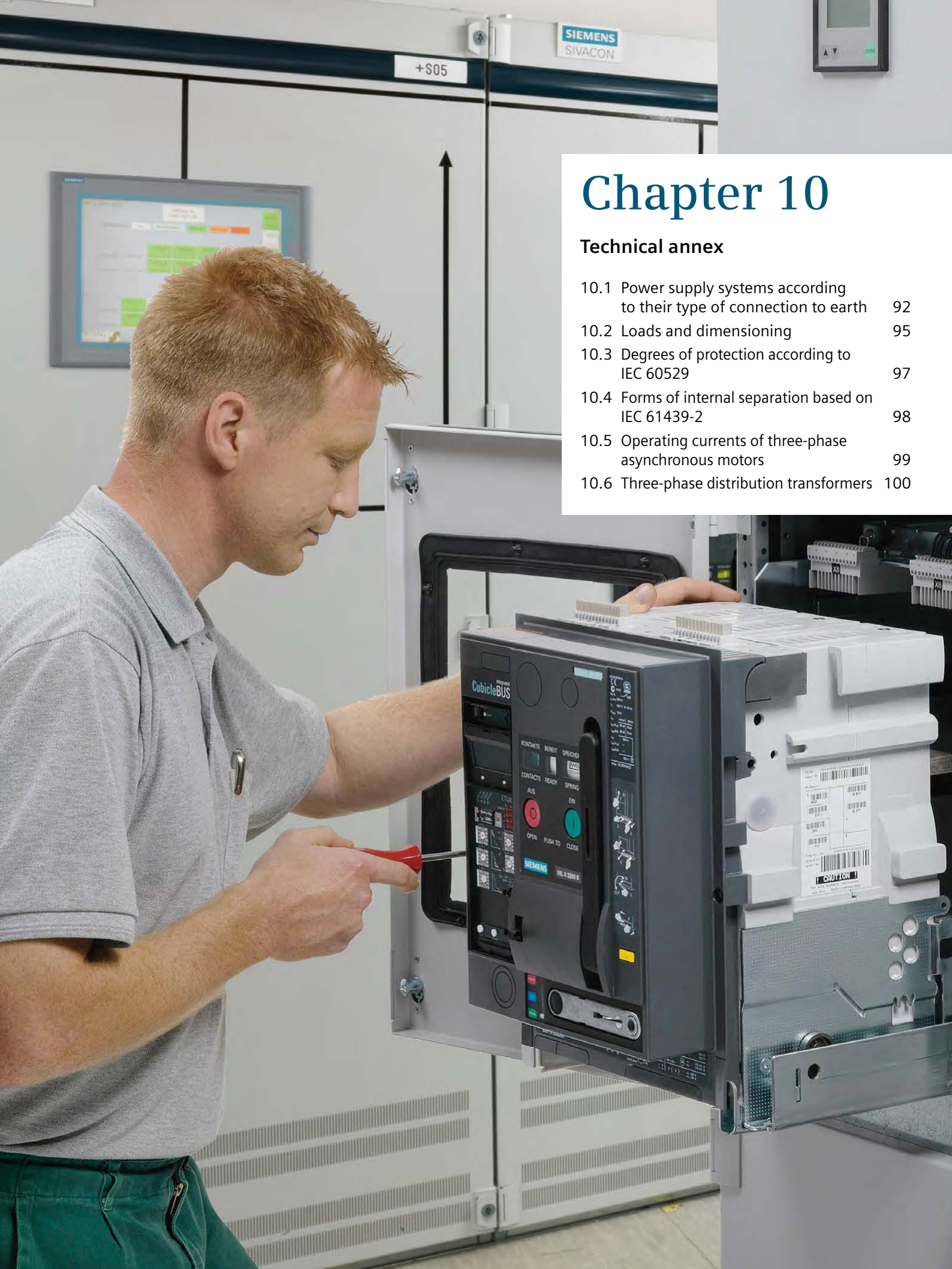

Chapter 10

Technical annex

10.1	Power supply systems according to their type of connection to earth	92
10.2	Loads and dimensioning	95
10.3	Degrees of protection according to IEC 60529	97
10.4	Forms of internal separation based on IEC 61439-2	98
10.5	Operating currents of three-phase asynchronous motors	99
10.6	Three-phase distribution transformers	100

10 Technical annex

10.1 Power supply systems according to their type of connection to earth

The power supply systems according the type of connection to earth considered for power distribution are described in IEC 60364-1. The type of connection to earth must be selected carefully for the low-voltage network, as it has a major impact on the expense required for protective measures (Fig. 10/1). On the low-voltage side, it also influences the system's electromagnetic compatibility

(EMC). From experience the TN-S system has the best cost-benefit ratio of electric networks at the low-voltage level. To determine the type of connection to earth, the entire installation from the power source (transformer) to the electrical consumer must be considered. The low-voltage switchboard is merely one part of this installation.

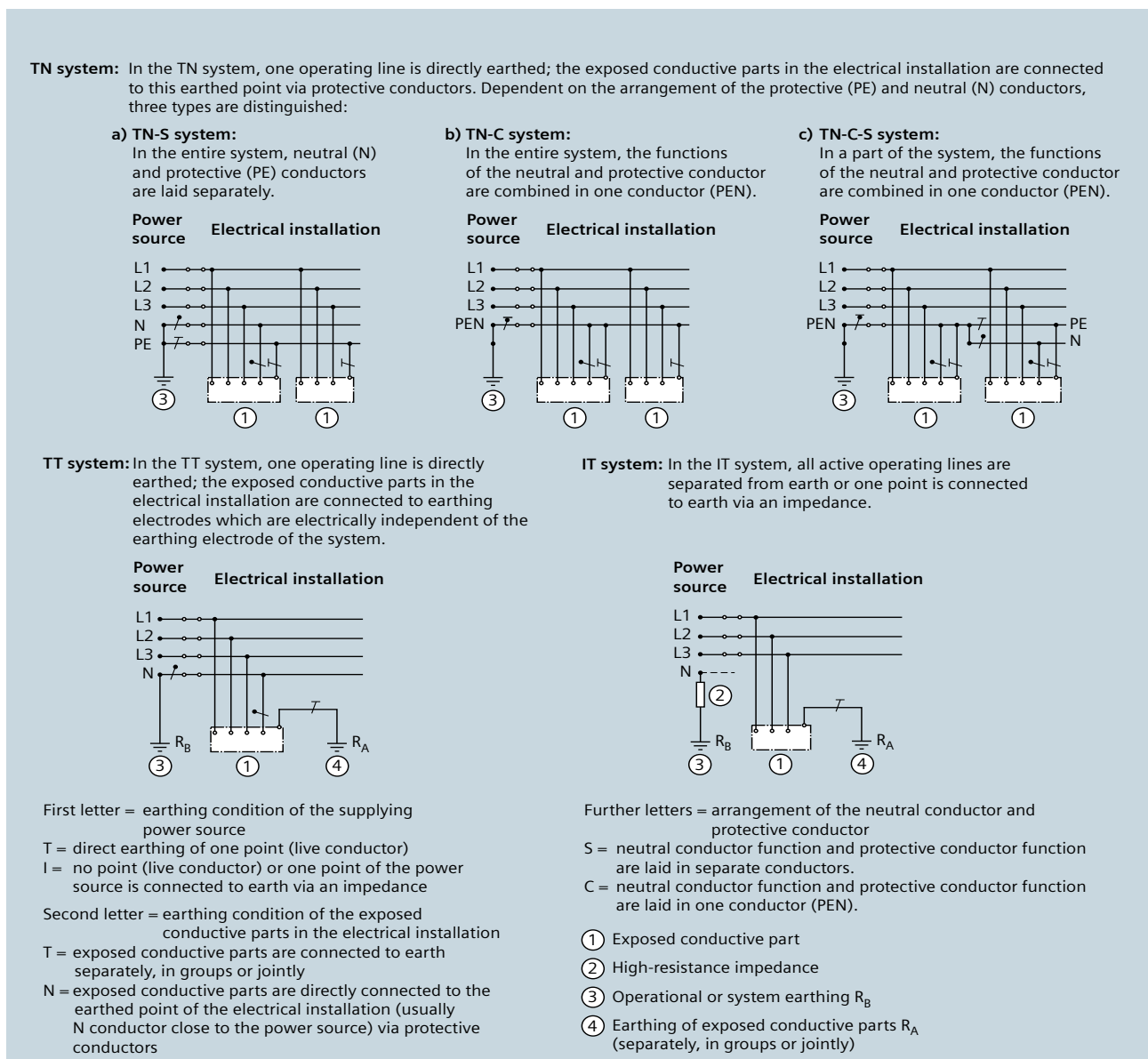

Fig. 10/1: Systems according to the type of connection to earth in accordance with IEC 60364-1

In the event of a short-circuit to an exposed conductive part in a TN system, a considerable proportion of the single-pole short-circuit current is not fed back to the power source through a connection to earth but through the protective conductor. The comparatively high single-pole short-circuit current allows for the use of simple protective devices such as fuses or miniature circuit-breakers, which clear the fault within the permissible fault disconnect time.

In building installations, networks with TN-S systems are preferably used today. When a TN-S system is used in the entire building, residual currents in the building, and thus an electromagnetic interference by galvanic coupling, can be prevented during normal operation because the operating currents flow back exclusively through the separately laid insulated N conductor. In case of a central arrangement of the power sources, the TN-S system can always be recommended. In that, the system earthing is implemented at one central earthing point (CEP) for all sources, for example in the main low-voltage distribution system.

Please note that neither the PEN nor the PE must be switched. If a PEN conductor is used, it is to be insulated over its entire course – this includes the distribution system (please refer to the example in Fig. 10/2). The magnitude of the single-pole short-circuit current directly depends on the position of the CEP.

Caution: In extensive supply networks with more than one splitter bridge, stray short-circuit currents may occur.

4-pole switches must be used if two TN-S subsystems are connected to each other. In TN-S systems, only one earthing bridge may be active at a time. Therefore, it is not permitted that two earthing bridges be interconnected via two conductors.

Today, networks with TT systems are still used in rural supply areas only and in few countries. In this context, the stipulated independence of the earthing systems must be

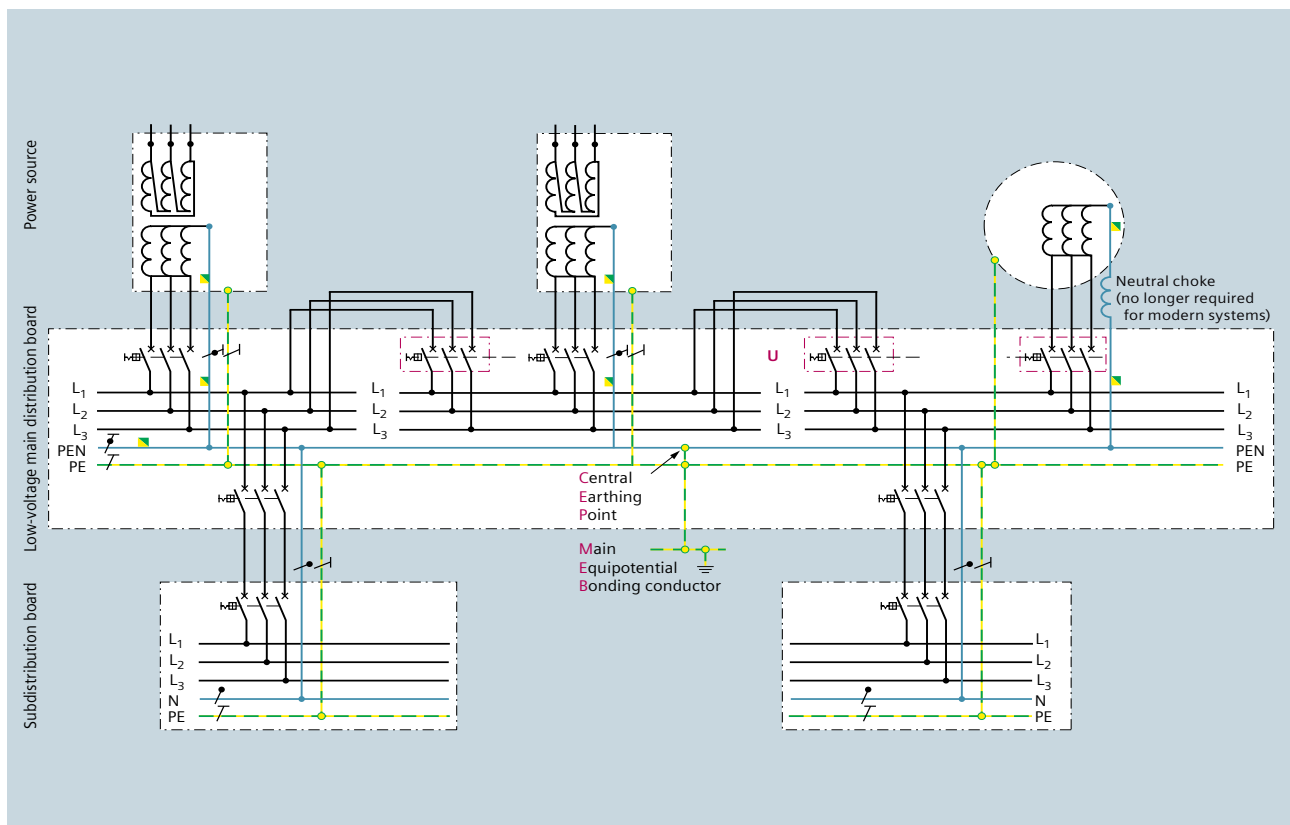

Fig. 10/2: Line diagram for an earthing concept based on a central earthing point (CEP)

1
2
3
4
5
6
7
8
9
10
11

observed. In accordance with IEC 60364-5-54, a minimum clearance ≥ 15 m is required.

Networks with an IT system are preferably used for rooms with medical applications in accordance with IEC 60364-7-710 in hospitals and in production, where no supply interruption is to take place upon the first fault, for example in the cable and optical waveguide production. The TT system as well as the IT system require the use of residual current devices (RCDs) – previously named FI (fault interrupters) – for almost every circuit.

Fault in the IT network

In the IT network, it is the phase-earth-phase fault – or double fault – which has to be managed by the circuit-breaker as the worst case fault at the load and supply side (Fig. 10/3). During such a fault, the full phase-to-phase voltage of 690 V, for example, is applied to the main contact, and simultaneously the high short-circuit current.

The product standard IEC 60947-2 for circuit-breakers calls for additional tests in accordance with Annex H of this standard to qualify them for use in non-earthed or impedance-earthed networks (IT systems). Accordingly, circuit-breaker specifications relating to the IT system must be observed.

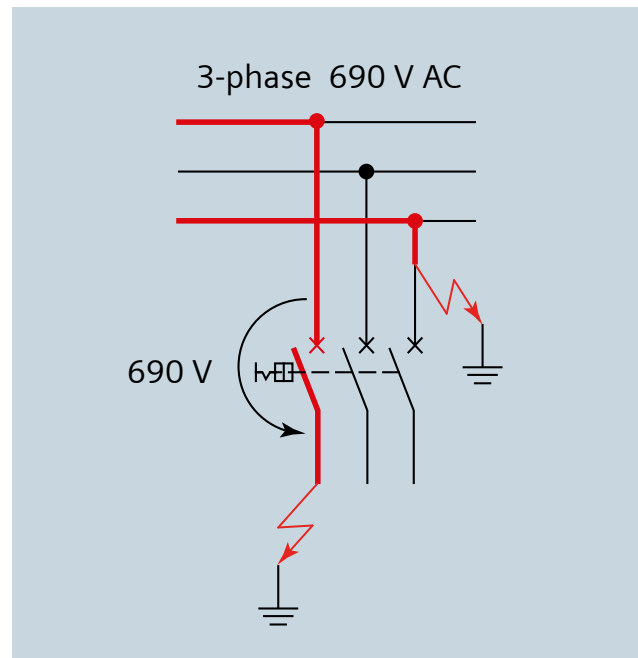

Fig. 10/3: Double fault in the IT system

10.2 Loads and dimensioning

Current carrying capacity considering the ambient temperature

The current carrying capacity can be calculated from the following relation taking the ambient temperature into account.

$$I_1^2 / I_2^2 = \Delta T_1 / \Delta T_2$$

Where the power ratio (of the currents squared) equals the ratio of temperature differences ΔT between object and ambience.

Example of a main busbar:

With a rated current $I_1 = 4,000 \text{ A}$ and a permissible busbar temperature $T_{SS} = 130 \text{ }^\circ\text{C}$,

there is a rated current I_2 for an ambient temperature $T_{env} = 40 \text{ }^\circ\text{C}$

$$I_2 = I_1 \times \sqrt{\frac{\Delta T_1}{\Delta T_2}} = I_1 \times \sqrt{\frac{(T_{SS} - T_{env})}{(T_{SS} - 35 \text{ }^\circ\text{C})}}$$

$$I_2 = 4,000 \text{ A} \times \sqrt{\frac{90 \text{ }^\circ\text{C}}{95 \text{ }^\circ\text{C}}} = \underline{3,893 \text{ A}}$$

Rated frequency 60 Hz

According to IEC 61439-1, section 10.10.2.3.1, the rated current at 60 Hz must be reduced to 95 % of its value at 50 Hz in case of currents greater than 800 A.

Short-circuit current carrying capacity of distribution busbars and functional units

IEC 61439-1, section 8.6.1 permits a reduction of the short-circuit strength of the vertical distribution busbar and its outgoing feeders in relation to the the main busbars "if these connections are arranged in such a way that a short circuit between phase and earthed parts needn't be expected under proper service conditions." The background for this simplification is the usually higher rated current of the main busbar compared to the currents of the distribution busbars, for the contact systems of the withdrawable units and in the feeder lines to the functional units. Lower temperature rises can be expected for these lower branching currents, so that it hardly makes sense to aim at the same dynamic and thermal short-circuit strength as for the main busbar.

Example:

To attain a required rated short-circuit strength of 100 kA, a 3VL5 MCCB with a switching capacity of 100 A is used as a short-circuit protective device:

In case of a disconnection on short circuit, merely a peak current of approximately 50 kA will flow as a let-through current for a short time, so that a root mean square value (RMS) of 35 kA can be assumed as maximum. It is only this reduced current which stresses the conductors in this circuit for the very short disconnect time of the breaker.

Test of dielectric properties

According to IEC 61439-1, section 10.9 the dielectric properties of the switchboard must be tested in consideration of devices having reduced dielectric properties. This means: "For this test, all the electrical equipment of the assembly shall be connected, except those items of apparatus which, according to the relevant specifications, are designed for a lower test voltage; current-consuming apparatus (e.g. windings, measuring instruments, voltage surge suppression devices) in which the application of the test voltage would cause the flow of a current, shall be disconnected. ... Such apparatus shall be disconnected at one of their terminals unless they are not designed to withstand the full test voltage, in which case all terminals may be disconnected."

1

2

3

4

5

6

7

8

9

10

11

Dimensioning of protective conductors

According to IEC 61439-1, section 8.4 and 8.8, an earth continuity connection (PE, PEN) must be ensured, which must meet the following requirements in accordance with IEC 61439-1.

- According to subsection 8.4.3.2.2:
"All exposed conductive parts of the assembly shall be interconnected together and to the protective conductor of the supply or via an earthing conductor to the earthing arrangement. These interconnections may be achieved either by metal screwed connections, welding or other conductive connections or by a separate protective conductor." Tab. 10/1 must be used for a separate protective conductor.
Furthermore, certain exposed conductive parts of the assembly which do not constitute a danger need not be connected to the protective conductor.
This applies
– "either because they cannot be touched on large surfaces or grasped with the hand
– or because they are of small size (approximately 50 mm by 50 mm) or so located as to exclude any contact with live parts."
"This applies to screws, rivets and nameplates. It also applies to electromagnets of contactors or relays, magnetic cores of transformers, certain parts of releases, or similar, irrespective of their size. When removable parts are equipped with a metal supporting surface, these surfaces shall be considered sufficient for ensuring earth continuity of protective circuits provided that the pressure exerted on them is sufficiently high."

- According to subsection 8.4.3.2.3:
"A protective conductor within the assembly shall be so designed that it is capable of withstanding the highest thermal and dynamic stresses arising from faults in external circuits at the place of installation that are supplied through the assembly. Conductive structural parts may be used as a protective conductor or a part of it." The following is required for PEN conductors in addition:
- Minimum cross section $\geq 10 \text{ mm}^2$ (Cu) or 16 mm^2 (Al)
- PEN cross section $> N$ cross section
- "Structural parts shall not be used as PEN conductors. However, mounting rails made of copper or aluminium may be used as PEN conductors."
- If the PEN current can reach high values (e.g. in electrical installations with many fluorescent lamps), it may be required that the PEN conductor has the same or a higher current carrying capacity as / than the phase conductor. This capacity value must be agreed separately between the assembly manufacturer and the user.
- According to section 8.8 (for terminals of protective conductors led into the assembly from the outside):
In the absence of a special agreement between the assembly manufacturer and the user, terminals for protective conductors shall be rated to accommodate copper conductors of a cross-sectional area based on the cross section of the corresponding phase conductor (see Tab. 10/2).

Tab. 10/1: Cross-sectional areas of protective conductors made of copper according to subsection 8.4.3.2.2 of IEC 61439-1

Rated operating current I_e	Minimum cross section of protective conductor
$I_e \leq 20$	S^1
$20 < I_e \leq 25$	2.5 mm^2
$25 < I_e \leq 32$	4 mm^2
$32 < I_e \leq 63$	6 mm^2
$63 < I_e$	10 mm^2

¹⁾ S = cross section of phase conductor in mm^2

Tab. 10/2: Minimum requirements for connecting protective copper conductors (PE and PEN) according to section 8.8 (from the outside) of IEC 61439-1

Permissible cross-sectional range of phase conductors S	Minimum cross section of corresponding protective conductor (PE, PEN) S_p ¹⁾
$S \leq 16 \text{ mm}^2$	S
$16 \text{ mm}^2 < S \leq 35 \text{ mm}^2$	16 mm^2
$35 \text{ mm}^2 < S \leq 400 \text{ mm}^2$	$\frac{1}{2} \times S$
$400 \text{ mm}^2 < S \leq 800 \text{ mm}^2$	200 mm^2
$800 \text{ mm}^2 < S$	$\frac{1}{4} \times S$

¹⁾ The neutral current can be influenced by load harmonics to a significant extent.

10.3 Degrees of protection according to IEC 60529

IEC 60529 establishes a classification system for degrees of protection ensured by an enclosure which relates to electrical equipment of a voltage rating up to 72.5 kV. The IP code (IP = international protection) described in this standard characterises the degrees of protection against access to hazardous parts, ingress of solid foreign bodies and the ingress of water which are ensured by an enclosure. It is briefly summarized in Tab. 10/3.

Tab. 10/3: Structure of the IP code and the meaning of code numerals and code letters

Code constituent	Code letter or code number	Meaning for the protection of equipment	Meaning for the safety of persons
International protection	IP	-	-
1 st code number:		Against the ingress of solid bodies	Against access to dangerous parts
	0	- (not protected)	- (not protected)
	1	≥ 50.0 mm in diameter	back of the hand
	2	≥ 12.5 mm in diameter	finger
	3	≥ 2.5 mm in diameter	tool
	4	≥ 1.0 mm in diameter	wire
	5	dust-protected	wire
	6	dust-proof	wire
2 nd code number:		Against the ingress of water with a damaging effect	-
	0	- (not protected)	
	1	vertical drops	
	2	drops to an angle of 15° (enclosure tilt 15°)	
	3	spray water	
	4	splash water	
	5	jet water	
	6	powerful jet water	
	7	temporary immersion	
	8	continuous immersion	
Additional letter (optional)		-	Against access to dangerous parts with a
	A		back of the hand
	B		finger
	C		tool
	D		wire
Additional letter (optional)		Supplementary information especially for	-
	H	high-voltage devices	
	M	movement during water test	
	S	standstill during water test	
	W	weather conditions	

1

2

3

4

5

6

7

8

9

10

11

10.4 Forms of internal separation based on IEC 61439-2

IEC 61439-2 describes possibilities how to subdivide power switchgear and controlgear assemblies. The following shall be attained by a subdivision into separate functional units, separate compartments or by enclosing conductive parts:

- Protection against contact with hazardous parts (minimum IPXXB, where XX represents any code numbers 1 and 2 of the IP code)
- Protection against ingress of solid foreign bodies (minimum IP2X, where X represents any 2nd code number)

Note: IP2X also covers IPXXB.

Internal separation can be ensured by partitions, or protective covers (barriers, made of metal or non-metal materials), insulation of exposed conductive parts or the integrated enclosure of devices, as implemented in the moulded-plastic circuit-breaker, for example. The forms of internal separation mentioned in IEC 61439-2 – form 1, 2a, 2b, 3a, 3b, 4a and 4b – are listed in Tab. 10/4.

Tab. 10/4: Internal separation of switchgear and controlgear assemblies in accordance with IEC 61439-2

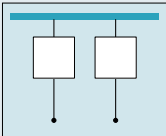
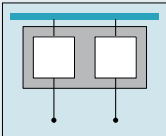
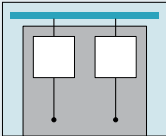
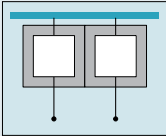
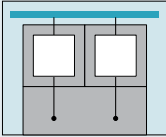
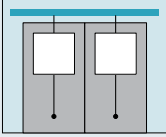
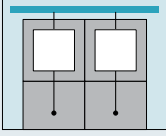
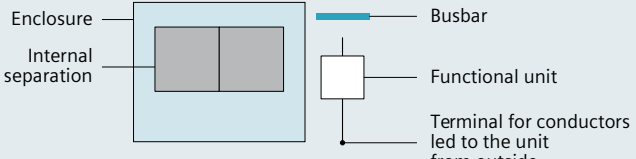
Form	Explanations	Form	Explanations	Block diagram
1	No internal separation	1	No internal separation	
2	Separation between busbars and functional units	2a	No separation between terminals and busbars	
		2b	Separation between terminals and busbars	
3	Separation between busbars and all functional units + Mutual separation of all functional units + Separation between the terminals of conductors led to the units from the outside and these functional units, not however between the terminals of these functional units	3a	No separation between terminals and busbars	
		3b	Separation between terminals and busbars	
4	Separation between busbars and all functional units + Mutual separation of all functional units + Separation between the terminals of conductors led to the units from the outside which are assigned to a functional unit and those terminals of all the other functional units and busbars	4a	Terminals in the same separation that is used for the connected functional unit	
		4b	Terminals not in the same separation that is used for the connected functional unit	
Legend:				

10.5 Operating currents of three-phase asynchronous motors

To enable the conversion of motor power values, Tab. 10/5 specifies guide values for the motor current present with different voltages.

Tab. 10/5: Guide values for the operating currents of three-phase asynchronous motors (AC-2/AC-3) in accordance with IEC 60947-4-1

Standard power P	Motor current I (guide value)		
	at 400 V	at 500 V	at 690 V
0.06 kW	0.20 A	0.16 A	0.12 A
0.09 kW	0.30 A	0.24 A	0.17 A
0.12 kW	0.44 A	0.32 A	0.23 A
0.18 kW	0.60 A	0.48 A	0.35 A
0.25 kW	0.85 A	0.68 A	0.49 A
0.37 kW	1.1 A	0.88 A	0.64 A
0.55 kW	1.5 A	1.2 A	0.87 A
0.75 kW	1.9 A	1.5 A	1.1 A
1.1 kW	2.7 A	2.2 A	1.6 A
1.5 kW	3.6 A	2.9 A	2.1 A
2.2 kW	4.9 A	3.9 A	2.8 A
3 kW	6.5 A	5.2 A	3.8 A
4 kW	8.5 A	6.8 A	4.9 A
5.5 kW	11.5 A	9.2 A	6.7 A
7.5 kW	15.5 A	12.4 A	8.9 A
11 kW	22 A	17.6 A	12.8 A
15 kW	29 A	23 A	17 A
18.5 kW	35 A	28 A	21 A
22 kW	41 A	33 A	24 A
30 kW	55 A	44 A	32 A
37 kW	66 A	53 A	39 A
45 kW	80 A	64 A	47 A
55 kW	97 A	78 A	57 A
75 kW	132 A	106 A	77 A
90 kW	160 A	128 A	93 A
110 kW	195 A	156 A	113 A
132 kW	230 A	184 A	134 A
160 kW	280 A	224 A	162 A
200 kW	350 A	280 A	203 A
250 kW	430 A	344 A	250 A

1

2

3

4

5

6

7

8

9

10

11

10.6 Three-phase distribution transformers

Important parameters for the connection of the SIVACON S8 low-voltage switchboard to three-phase distribution transformers are listed in Tab. 10/6.

Approximation formulas for current estimation, if there are no specified table values:

For the rated transformer current by approximation:

$$I_r = k \times S_{rT}$$

For the initial symmetrical transformer short-circuit current by approximation:

$$I_k'' = I_r / u_{kr}$$

Exemplified by

- Rated transformer power $S_{rT} = 500$ kVA
- Voltage factor k
 - $k = 1.45$ A/kVA for a rated voltage of 400 V
 - $k = 1.1$ A/kVA for a rated voltage of 525 V
 - $k = 0.84$ A/kVA for a rated voltage of 690 V
- Rated short-circuit voltage $u_{kr} = 4\%$

there are the following approximations for $U_r = 400$ V:

$$I_r = (1.45 \times 500) \text{ A} = 725 \text{ A}$$

$$I_k'' = (725 \times 100 / 4) \text{ A} = 18.125 \text{ kA}$$

Tab. 10/6: Rated currents and initial symmetrical short-circuit currents of three-phase distribution transformers

Rated power S_{rT}	Rated voltage								
	400 V AC / 50 Hz			525 V AC / 50 Hz			690 V AC / 50 Hz		
		Rated value of the short-circuit voltage u_{kr}			Rated value of the short-circuit voltage u_{kr}			Rated value of the short-circuit voltage u_{kr}	
		4 %	6 %		4 %	6 %		4 %	6 %
	Rated current I_r	Initial short-circuit alternating current I_k'' ¹⁾		Rated current I_r	Initial short-circuit alternating current I_k'' ¹⁾		Rated current I_r	Initial short-circuit alternating current I_k'' ¹⁾	
50 kVA	72 A	1,933 A	1,306 A	55 A	1,473 A	995 A	42 A	1,116 A	754 A
100 kVA	144 A	3,871 A	2,612 A	110 A	2,950 A	1,990 A	84 A	2,235 A	1,508 A
160 kVA	230 A	6,209 A	4,192 A	176 A	4,731 A	3,194 A	133 A	3,585 A	2,420 A
200 kVA	288 A	7,749 A	5,239 A	220 A	5,904 A	3,992 A	167 A	4,474 A	3,025 A
250 kVA	360 A	9,716 A	6,552 A	275 A	7,402 A	4,992 A	209 A	5,609 A	3,783 A
315 kVA	455 A	12,247 A	8,259 A	346 A	9,331 A	6,292 A	262 A	7,071 A	4,768 A
400 kVA	578 A	15,506 A	10,492 A	440 A	11,814 A	7,994 A	335 A	8,953 A	6,058 A
500 kVA	722 A	19,438 A	13,078 A	550 A	14,810 A	9,964 A	418 A	11,223 A	7,581 A
630 kVA	910 A	24,503 A	16,193 A	693 A	18,669 A	12,338 A	525 A	14,147 A	9,349 A
800 kVA	1,154 A	-	20,992 A	880 A	-	15,994 A	670 A	-	12,120 A
1,000 kVA	1,444 A	-	26,224 A	1,100 A	-	19,980 A	836 A	-	15,140 A
1,250 kVA	1,805 A	-	32,791 A	1,375 A	-	24,984 A	1,046 A	-	18,932 A
1,600 kVA	2,310 A	-	41,857 A	1,760 A	-	31,891 A	1,330 A	-	24,265 A
2,000 kVA	2,887 A	-	52,511 A	2,200 A	-	40,008 A	1,674 A	-	30,317 A
2,500 kVA	3,608 A	-	65,547 A	2,749 A	-	49,941 A	2,090 A	-	37,844 A
3,150 kVA	4,550 A	-	82,656 A	3,470 A	-	62,976 A	2,640 A	-	47,722 A

¹⁾ I_k'' uninfluenced initial symmetrical transformer short-circuit current in consideration of the voltage and correction factor of the transformer impedance in accordance with IEC 60909-0, without considering the system source impedance

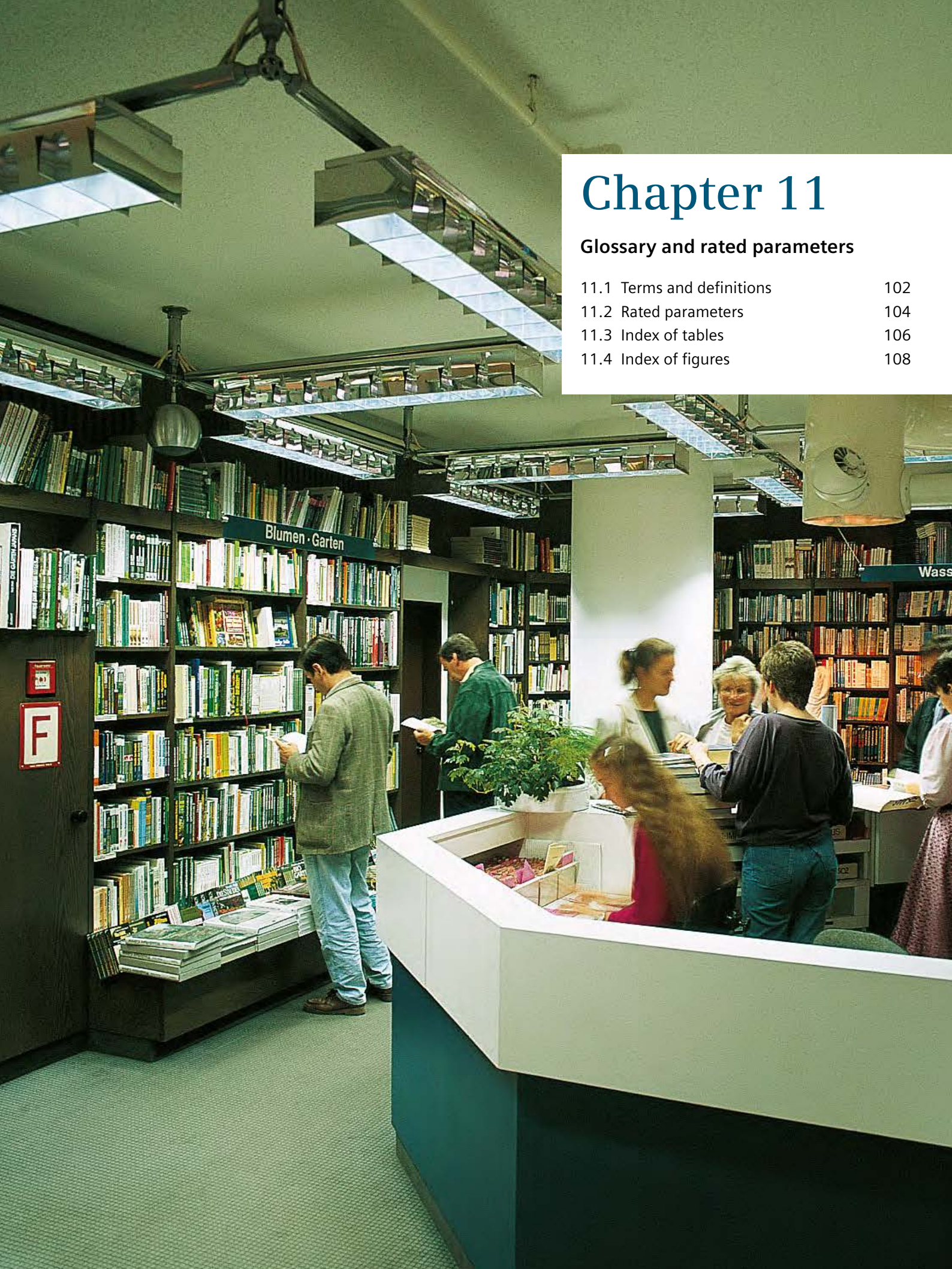

Chapter 11

Glossary and rated parameters

11.1 Terms and definitions	102
11.2 Rated parameters	104
11.3 Index of tables	106
11.4 Index of figures	108

11 Glossary and rated parameters

11.1 Terms and definitions

The information provided in the two standards IEC 61439-1 and -2 is used to explain the relevant terms referred to in this planning manual:

Low-voltage switchgear and controlgear assembly (assembly)

Combination of one or more low-voltage switching devices together with associated control, measuring, signalling, protective, regulating equipment, with all the internal electrical and mechanical interconnections and structural parts

Assembly system

Full range of mechanical and electrical components (enclosures, busbars, functional units, etc.), as defined by the original manufacturer, which can be assembled in accordance with the original manufacturer's instructions in order to produce various assemblies

Power switchgear and controlgear assembly (PSC assembly)

Low-voltage switchgear and controlgear assembly which is used to distribute and control electric energy for all types of loads, in industrial commercial and similar applications not intended to be operated by ordinary persons

Design verification

Verification performed on a sample of an assembly or parts of assemblies to show that the type meets the requirements of the relevant assembly standard (Note: The design verification may comprise one or more equivalent and alternative methods such as tests, calculations, physical measurements or the application of construction rules)

Verification test

Test performed on a sample of an assembly or parts of assemblies to verify that the type meets the requirements of the relevant assembly standard (Note: "Verification tests" correspond to "type tests" as described in the no longer valid IEC 60439-1 standard)

Verification assessment

Design verification of strict construction rules or calculations applied to a sample of an assembly or parts of assemblies to show that the type meets the requirements of the relevant assembly standard

Construction rule

Defined rules for the construction of an assembly which may be applied as an alternative to a verification test

Routine verification

Verification of each assembly performed during and/or after manufacture to confirm whether it complies with the requirements of the relevant assembly standard

Functional unit

Part of an assembly comprising all the electrical and mechanical elements including switching devices that contribute to the fulfilment of the same function

Removable part

Part which may be removed in whole from the assembly for replacement, even if the connected circuit is energised

Withdrawable unit

Removable part, which can be brought from a connected position to a disconnected position, or, if applicable, to a test position, while it remains mechanically connected to the power switchgear and controlgear assembly

Connected position

Position of a removable part (or withdrawable unit) when it is fully connected for the intended function

Test position

Position of a withdrawable unit in which the relevant main circuits are open on the incoming side, while the requirements placed upon an isolating gap need not be met, and in which the auxiliary circuits are connected in a manner that assures that the withdrawable unit undergoes a function test while it remains mechanically connected to the switchgear and controlgear assembly (Note: The opening may also be established by operating a suitable device without the withdrawable unit being mechanically moved)

Disconnected position

Position of a withdrawable unit in which the isolating gaps in the main and auxiliary circuits are open while it remains mechanically connected to the assembly (Note: The isolating gap may also be established by operating a suitable device without the withdrawable unit being mechanically moved)

Isolating gap

Clearance in air between open contacts which meets the safety requirements defined for the disconnector

Removed position

Position of a removable part or withdrawable unit which has been removed from the switchgear and controlgear assembly and is mechanically and electrically disconnected from the assembly

Supporting structure (frame)

Part which is an integral part of a switchgear and controlgear assembly and which is intended to hold various components of such an assembly and an enclosure

Enclosure

Housing providing the type and degree of protection suitable for the intended application

Cubicle

Constructional unit of an assembly between two successive vertical delineations

Sub-section

Constructional unit of an assembly between two successive horizontal or vertical delineations within a section

Compartment

Cubicle or sub-section enclosed except for openings necessary for interconnection, control or ventilation

Coding device

Device which prevents a removable part to be placed in a position not intended for this removable part

Transport unit

Part of an assembly or a complete assembly suitable for transportation without being dismantled

Operating gangway within a PSC assembly

Space the operator must enter to be able to operate and monitor the power switchgear and controlgear assembly properly

Maintenance gangway within a PSC assembly

Space which is only accessible for authorized persons and which is mainly intended for the maintenance of built-in equipment

1

2

3

4

5

6

7

8

9

10

11

11.2 Rated parameters

The manufacturers of low-voltage switchgear and controlgear assemblies specify rated values in accordance with IEC 61439-1 and -2. For the low-voltage switching devices applied, rated values must be stated which are in accordance with the relevant product-specific standards from the IEC 60947 series. These rated values apply to defined operating conditions and characterise the usability of a switchgear and controlgear assembly.

The following ratings in accordance with IEC 61439-1 and -2 shall be the basis for assembly configurations:

Rated voltage U_n

The highest nominal value of alternating (root mean square value) or direct voltage specified by the assembly manufacturer for which the main circuits of the switchgear and controlgear assembly are designed.

Rated operational voltage U_e (of a circuit in an assembly)

Value of voltage, declared by the assembly manufacturer, which combined with the rated current determines its application.

Rated insulation voltage U_i

Root mean square withstand voltage value, assigned by the assembly manufacturer to the equipment or to a part of it, characterising the specified (long-term) withstand capability of its insulation.

Rated impulse withstand voltage U_{imp}

Impulse withstand voltage value, declared by the assembly manufacturer, characterising the specified withstand capability of the insulation against transient overvoltages.

Rated current I_n

Value of current declared by the assembly manufacturer which considers the equipment ratings and their arrangement and use. It can be carried without the temperature rise of various parts of the assembly exceeding specified limits under specified conditions.

Rated peak withstand current I_{pk}

Value of peak short-circuit current, declared by the assembly manufacturer, that can be withstood under specified conditions.

Rated short-time withstand current I_{cw}

The root mean square value of short-time current, declared by the assembly manufacturer, that can be withstood under specified conditions, defined in terms of a current and time.

Time values > 1 s can be converted with

$$I^2 \times t = \text{constant.}$$

For example, from $I_{cw} = 50$ kA, 1 s, $I_{cw} = 28.9$ kA can be calculated for 3 s:

$$I_{cw}(t_2) = I_{cw}(t_1) \times \sqrt{\frac{t_1}{t_2}}$$

$$I_{cw}(3 \text{ s}) = 50 \text{ kA} \times \sqrt{\frac{1 \text{ s}}{3 \text{ s}}} = 28.9 \text{ kA}$$

Factor $n = I_{pk} / I_{cw}$

To determine the surge current, the root mean square value of the short-circuit current must be multiplied with factor n . Tab. 11/1 lists values for n from IEC 61439-1.

Tab. 11/1: Factor n as a function of $\cos \varphi$ and I_{cw}

n	$\cos \varphi$	Rated short-time withstand current I_{cw}
1.5	0.7	$I_{cw} \leq 5 \text{ kA}$
1.7	0.7	$5 \text{ kA} < I_{cw} \leq 10 \text{ kA}$
2	0.3	$10 \text{ kA} < I_{cw} \leq 20 \text{ kA}$
2.1	0.25	$20 \text{ kA} < I_{cw} \leq 50 \text{ kA}$
2.2	0.2	$5 \text{ kA} < I_{cw}$

Rated conditional short-circuit current I_{cc}

Value of prospective short-circuit current, declared by the assembly manufacturer, that can be withstood for the total operating time (clearing time, duration of current flow) of the short-circuit protective device (SCPD) under specified conditions.

Rated current of the assembly I_{nA}

The rated current of the assembly is the smaller of:

- the sum of the rated currents of the incoming circuits within the assembly operated in parallel;
- the total current which the main busbar is capable of distributing in the particular assembly configuration.

Rated current of a circuit I_{nc}

The rated current of a circuit which is specified by the assembly manufacturer depends on the rated values of the individual items of electrical equipment in the circuit within the assembly, their arrangement and their type of application. The circuit must be capable of carrying this current when operated alone without that overtemperatures in individual components will exceed the limit values specified.

Rated diversity factor (RDF)

The rated diversity factor is the rated current value given as a percentage by the assembly manufacturer, the outgoing feeders of an assembly can continuously and simultaneously be loaded with taking the mutual thermal influences into account.

The rated diversity factor may be specified

- for groups of circuits
- for the entire switchgear and controlgear assembly

The rated current of the circuits I_{nc} multiplied by the rated diversity factor must be greater than or equal to the assumed outgoing feeder load.

The rated diversity factor recognizes that several outgoing feeders in a cubicle are in practice loaded intermittently, or not fully loaded simultaneously. However, if there is no agreement between manufacturer and user as to the real loading of the outgoing feeder circuits, the values given in Tab. 11/2 shall be applied.

Tab. 11/2: Rated diversity factors RDF for various load types

Type of loading	Assumed diversity factor
Power distribution: 2 - 3 circuits	0.9
Power distribution: 4 - 5 circuits	0.8
Power distribution: 6 - 9 circuits	0.7
Power distribution: 10 circuits and more	0.6
Electric actuators	0.2
Motors ≤ 100 kW	0.8
Motors > 100 kW	1

If equipment is to be coordinated which is used in a switchboard, the rated values given in the IEC 60947 product standards shall be the basis:

Trip class – CLASS

Trip classes define time intervals within which the protective devices (overload trip units of circuit breakers or overload relays) must trip in cold state when assuming a symmetrical 3-phase load of 7.2 times the setting current:

- CLASS 5, CLASS 10:
for standard applications (normal starting)
- CLASS 20, CLASS 30, CLASS 40:
for applications with a high starting current over a longer period of time

In addition to the overload protective devices, the contactors and the short-circuit fuses must also be dimensioned for longer starting times.

Short-circuit breaking capacity

The short-circuit breaking capacity is the short-circuit current declared by the manufacturer which is capable of switching off the device / motor starter under specified conditions.

Type of co-ordination

The type of co-ordination describes the permissible degree of damage after a short circuit. Under no circumstances must persons or the installation be endangered in the event of a short circuit.

Specifically: Type of co-ordination 2 or "Type 2"

The starter remains operable. No damage must be present on devices with the exception of slight contactor contact welding, if these contacts can be easily separated without any substantial deformation.

Pollution degree

The pollution degree refers to the environmental conditions for which the assembly is intended. For switching devices and components inside an enclosure, the pollution degree of the environmental conditions in the enclosure is applicable.

For the purpose of evaluating clearances and creepage distances four degrees of pollution in the micro-environment are established.

Specifically: Pollution degree 3

Conductive pollution occurs or dry, non-conductive pollution occurs which is expected to become conductive due to condensation.

1

2

3

4

5

6

7

8

9

10

11

11.3 Index of tables

Tab.	Title	Page
Chapter 2		
2/1	Technical data, standards and approvals for the SIVACON S8 switchboard	8
2/2	Schematic overview of switchboard configurations for SIVACON S8	10
2/3	Cubicle types and busbar arrangement	12
2/4	Cubicle dimensions	14
2/5	Surface treatment	14
2/6	Dimensions of the corner cubicles	15
2/7	Rating of the main busbar	16
2/8	Cubicle widths for earthing short-circuit points	17
2/9	Cable terminal for the main earthing busbar	17
2/10	Basic data of the different mounting designs	18
Chapter 3		
3/1	General cubicle characteristics in circuit-breaker design	23
3/2	Cubicle dimensions for top busbar position	24
3/3	Cubicle dimensions for rear busbar position	25
3/4	Cubicle dimensions for rear busbar position with two busbar systems in the cubicle	26
3/5	Cable connection for cubicles with 3WL	27
3/6	Rated currents for cubicles with one 3WL	28
3/7	Dimensions for cubicles with three ACB of type 3WL	29
3/8	Cable connection in cubicles with up to three ACB	29
3/9	Rated currents for special load cases of a circuit-breaker cubicle with three 3WL11 circuit-breakers in the cubicle	29
3/10	Widths for incoming/outgoing feeder cubicles with MCCB	30
3/11	Cable connection for cubicles with MCCB of type 3VL	30
3/12	Rated currents for cubicles with 3VL	30
3/13	Cubicle width for direct supply and direct feeder	31
3/14	Cable connection for direct supply and direct feeder	31
3/15	Rated currents for direct supply and direct feeder	31

Tab.	Title	Page
Chapter 4		
4/1	General cubicle characteristics for the universal mounting design	34
4/2	Ratings of the vertical distribution busbar	36
4/3	Cubicle characteristics for the fixed-mounted design	37
4/4	Connection cross sections in fixed-mounted cubicles with a front door	37
4/5	Ratings for cable feeders	37
4/6	Cubicle characteristics for in-line switch-disconnectors	38
4/7	General cubicle characteristics for the withdrawable design	38
4/8	Characteristics of withdrawable units in SFD	39
4/9	Connection data for the main circuit	40
4/10	Connection data for the auxiliary circuit	40
4/11	Number of available auxiliary contacts for withdrawable units in SFD	40
4/12	Withdrawable units in HFD	41
4/13	Characteristics of the withdrawable units in HFD	42
4/14	Connection data for the main circuit	44
4/15	Connection data for the auxiliary circuit	44
4/16	Number of available auxiliary contacts for withdrawable units in HFD	44
4/17	Rated currents and minimum withdrawable unit heights for cable feeders in SFD / HFD	45
4/18	Minimum withdrawable unit sizes for: fused motor feeders, 400 V, CLASS 10, with overload relay, type 2 at 50 kA	46
4/19	Minimum withdrawable unit sizes for: fused motor feeders, 400 V, CLASS 10, with SIMOCODE, type 2 at 50 kA	47
4/20	Minimum withdrawable unit sizes for: fuseless motor feeders, 400 V, CLASS 10, overload protection with circuit-breaker, type 2 at 50 kA	47
4/21	Minimum withdrawable unit sizes for: fuseless motor feeders, 400 V, CLASS 10, with overload relay, type 2 at 50 kA	48
4/22	Minimum withdrawable unit sizes for: fuseless motor feeders, 400 V, CLASS 10, with SIMOCODE, type 2 at 50 kA	48

Tab.	Title	Page
Chapter 5		
5/1	General cubicle characteristics for in-line design, plug-in	50
5/2	Rating data of the vertical distribution busbar 3NJ62	51
5/3	Additional built-in elements for 3NJ62	51
5/4	Derating factors for 3NJ62 fuse links	51
5/5	Rating data of the 3NJ62 cable feeders	51
5/6	Conversion factors for different ambient temperatures	52
5/7	Configuration rules for 3NJ62: arrangement of the in-line units in the cubicle	52
5/8	Rating data of the vertical distribution busbar SASIL plus	53
5/9	Additional built-in elements for SASIL plus	53
5/10	Derating factors for SASIL plus fuse links	53
5/11	Rating data of the SASIL plus cable feeders	53
5/12	Conversion factors for different ambient temperatures	54
5/13	Configuration rules for SASIL plus: arrangement of the in-line units in the cubicle	54
Chapter 6		
6/1	General cubicle characteristics for fixed-mounted in-line design	57
6/2	Rating data of the 3NJ4 cable feeders	57
6/3	Dimensions if additional built-in elements are used	58
6/4	Mounting location of additional built-in elements	58
6/5	Device compartment for in-line units in the 2nd row	58
6/6	Rating data of the cable feeders for in-line units in the 2nd row	58
6/7	General cubicle characteristics for fixed-mounted cubicles with front cover	59
6/8	Rating data of the vertical distribution busbar	60
6/9	Conductor cross sections in fixed-mounted cubicles with a front door	60
6/10	Rating data of the cable feeders for fuse-switch-disconnectors and switch-disconnectors with fuses	61
6/11	Rating data of the cable feeders for circuit-breakers	62
6/12	Configuration data of the mounting kits for modular installation devices	62
6/13	General characteristics for cubicles for customized solutions	63
6/14	Configuration data on cubicle design for customized solutions	64
6/15	Rating data of the vertical distribution busbar	64
6/16	Configuration data on mounting options for customized solutions	64

Tab.	Title	Page
Chapter 7		
7/1	General characteristics of cubicles for reactive power compensation	66
7/2	Choked capacitor modules with built-in audio frequency suppressor	67
7/3	Configuration of capacitor modules	68
7/4	Conversion factors F for phase angle adjustments	69
7/5	Connecting cables and back-up fuses for separately installed compensation cubicles	70
Chapter 8		
8/1	Weights of SIVACON S8 cubicles (orientation values)	76
8/2	Power losses of SIVACON S8 cubicles (orientation values)	76
8/3	Normal service conditions for SIVACON S8 switchboards	77
8/4	Special service conditions for SIVACON S8 switchboards	78
Chapter 9		
9/1	Test for the design verification in accordance with IEC 61439-2	80
9/2	SIVACON S8 system characteristics under arcing conditions	82
9/3	SIVACON S8 arc levels (system areas to which the internal arc is limited are marked in orange)	82
9/4	SIVACON S8 system characteristics under earthquake conditions	83
9/5	Acceleration factor K for SIVACON S8	83
Chapter 10		
10/1	Cross-sectional areas of protective conductors made of copper according to subsection 8.4.3.2.2 of IEC 61439-1	96
10/2	Minimum requirements for connecting protective copper conductors (PE and PEN) according to section 8.8 (from the outside) of IEC 61439-1	96
10/3	Structure of the IP code and the meaning of code numerals and code letters	97
10/4	Internal separation of switchgear and controlgear assemblies in accordance with IEC 61439-2	98
10/5	Guide values for the operating currents of three-phase asynchronous motors (AC-2/AC-3) in accordance with IEC 60947-4-1	99
10/6	Rated currents and initial symmetrical short-circuit currents of three-phase distribution transformers	100
Chapter 11		
11/1	Factor n as a function of $\cos \varphi$ and I_{cw}	104
11/2	Rated diversity factors RDF for various load types	105

11.4 Index of figures

Fig.	Title	Page
Chapter 1		
1.1	Totally Integrated Power (TIP) as holistic approach to electric power distribution	4
1.2	SIVACON S8 for all areas of application	5
1.3	Use of SIVACON S8 in power distribution	6
Chapter 2		
2/1	Cubicle design of SIVACON S8	9
2/2	Dimensions of enclosure parts	14
2/3	Integration of the corner cubicle	15
2/4	Variable busbar position for SIVACON S8	16
Chapter 3		
3/1	Cubicles in circuit-breaker design	22
3/2	Forced cooling in a circuit-breaker cubicle	23
3/3	Cubicle types for direct supply and direct feeder (refer to the text for explanations)	31
Chapter 4		
4/1	Cubicles for universal mounting design: on the left with front cable connection; on the right for rear cable connection	34
4/2	Cubicle with forced cooling for universal mounting design	35
4/3	Combination options for universal mounting design	36
4/4	Equipment in fixed-mounted design (left) and connection terminals in the cable connection compartment (right)	37
4/5	Design variants of the withdrawable units in standard feature design (SFD; left) and high feature design (HFD; right)	38
4/6	Positions in the SFD contact system	39
4/7	Normal withdrawable unit in SFD with a withdrawable unit height of 100 mm	39
4/8	Open withdrawable unit compartments in SFD	40
4/9	Structure of a small withdrawable unit in HFD	41
4/10	Positions in the HFD contact system	41
4/11	Front areas usable for an instrument panel on small withdrawable units with an installation height of 150 mm	43
4/12	Front areas usable for an instrument panel on small withdrawable units with an installation height of 200 mm	43
4/13	Front areas usable for an instrument panel on normal withdrawable units	43
4/14	Compartment for normal withdrawable unit in HFD	44
4/15	Adapter plate for small withdrawable units	44
Chapter 5		
5/1	Cubicles for in-line design, plug-in: on the left for in-line switch-disconnectors 3NJ62 with fuses, on the right for switch-disconnectors SASIL plus with fuses	50
5/2	Pluggable in-line switch-disconnectors 3NJ62	51
5/3	Pluggable in-line switch-disconnectors SASIL plus	53

Fig.	Title	Page
Chapter 6		
6/1	Cubicles for fixed-mounted in-line design with 3NJ4 in-line switch-disconnectors	56
6/2	Cubicles for fixed mounting with front cover	59
6/3	Installation of switching devices in fixed-mounted cubicles with a front cover (cover opened)	60
6/4	Cable connections in fixed-mounted cubicles with a front cover	60
6/5	Mounting kit for modular installation devices (without cover)	62
6/6	Cubicles for customized solutions	63
Chapter 7		
7/1	Cubicle for reactive power compensation	66
7/2	Capacitor modules for reactive power compensation	67
Chapter 8		
8/1	Clearances to obstacles	72
8/2	Maintenance gangway widths and passage heights	72
8/3	Minimum widths of maintenance gangways in accordance with IEC 60364-7-729	73
8/4	Cubicle arrangement for single-front (top) and double-front systems (bottom)	74
8/5	Permissible deviations of the installation area	75
8/6	Installation on raised floors	75
8/7	Foundation frame mounted on concrete	75
8/8	Mounting points of the single-front system	75
8/9	Mounting points of the single-front system	75
8/10	Mounting points for the corner cubicle	75
Chapter 9		
9/1	Insulated main busbar in the SIVACON S8 (optional N insulation)	81
9/2	Arc barrier in SIVACON S8	81
9/3	Comparison of seismic scales for the classification of seismic response categories of SIVACON S8	84
9/4	EC-Declaration of Conformity for SIVACON S8 in respect of the Low Voltage and EMC Directives	86
9/5	Declaration of Conformity for SIVACON S8 regarding design verification	87
9/6	Declaration of Conformity for SIVACON S8 regarding design verification - Annex Page 1/2	88
9/7	Declaration of Conformity for SIVACON S8 regarding design verification - Annex Page 2/2	89
Chapter 10		
10/1	Systems according to the type of connection to earth in accordance with IEC 60364-1	92
10/2	Double fault in the IT system	93
10/3	Double fault in the IT system	94

Siemens AG

Energy Management
Medium Voltage & Systems
Mozartstr. 31c
D-91052 Erlangen
Germany

All rights reserved.

All data and circuit examples without engagement.

Subject to change without prior notice.

www.siemens.com/sivacon-s8

Order no.: IC1000-G320-A220-V3-7600

© 2015 Siemens AG

The information in this manual only includes general descriptions and/or performance characteristics, which do not always apply in the form described in a specific application, or which may change as products are developed. The required performance characteristics are only binding, if they are expressly agreed at the point of conclusion of the contract.

All product names may be trademarks or product names of Siemens AG or supplier companies; use by third parties for their own purposes could violate the rights of the owner.